



El Paso Streetcar Track Access Training



Provided by the Sun Metro Streetcar Operations Team | 2023



STREETCAR

Purpose and scope

- The purpose of this procedure is to maintain a safe environment and provide an efficient transit system for customers, employees, contractors, and Permittee when work or events are being performed on the El Paso Streetcar (**EPSC**) Operational Right-of-Way (**ROW**), or within the vicinity of the **EPSC**.
- To maintain a safe environment for anyone requiring track access to the **EPSC Operational ROW** and/or has the **POTENTIAL** to affect the operation of the El Paso Streetcar



Applicability

- City Of El Paso Ordinance 018824 - Title 13 (Streets, Sidewalks and Public Places) be amended to add a new Chapter 13.42 as follows:
 - Chapter 13.42- Streetcar Track Access Program Procedure
- Any person or entity performing any activity under any Streetcar Infrastructure or within 10 feet of any Streetcar Infrastructure **MUST COMPLY** with the Track Access Program Procedure as adopted and amended by the Streetcar Safety Officer from time to time
- **Activity:** means the following:
 - Any construction, demolition, event, moving event, excavation, use of the right of way, cleaning, painting, repairing, or installation of traffic control devices, regardless of whether any of the previous requires the approval of the City under the El Paso City Code; or
 - Any activity under the El Paso City Code that requires a permit, license, permission, or review from the City or other regulatory entity.



Applicability

- Streetcar Infrastructure means any component or item used for the operation of the Streetcar, including but not limited to, the railcars, track works, traction power substations, overhead contact systems, overhead contact system poles, train wayside communications systems, and/or the streetcar maintenance facility.
- Any project or event starting within 10 feet of the center of the track, overhead wire or EPSC infrastructure falls on the area known as the Streetcar Dynamic Safety Envelope or the Streetcar Operational Right-of-Way.



Dynamic Safety Envelope

EXHIBIT

C



OPERATIONAL RIGHT-OF-WAY
DYNAMIC SAFETY ENVELOPE

10/20/2019

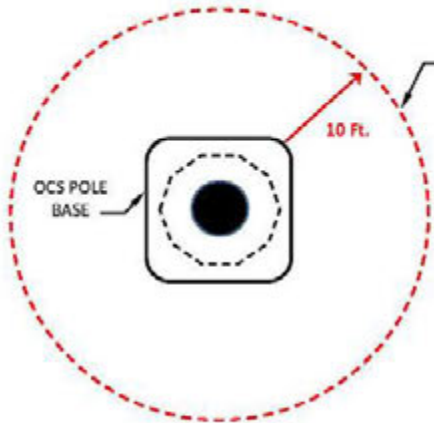

TYPICAL PLAN VIEW – OVERHEAD CONTACT SYSTEM (OCS) POLE – SCALE: N.T.S.

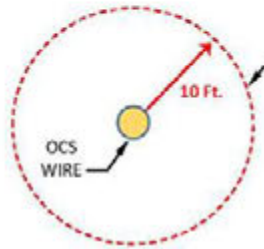

TYPICAL SECTION VIEW – OVERHEAD CONTACT SYSTEM (OCS) WIRE – SCALE: N.T.S.

GENERAL NOTES:

1. THE DYNAMIC SAFETY ENVELOPE (DSE) EXTENDS 10 FEET Laterally FROM THE CENTERLINE OF THE TRACK, 10 FEET SURROUNDING THE OCS WIRE, AND 10 FEET SURROUNDING ANY OTHER STREETCAR INFRASTRUCTURE, INCLUDING OCS POLES AND APPURTENANCES.
2. THE DSE ALSO EXTENDS 10 FEET BELOW GRADE FROM THE TOP OF THE FINISHED TRACK ELEVATION.
3. THE STREETCAR ZONE OF INFLUENCE EXTENDS 25 FEET FROM THE CENTERLINE OF THE TRACK FOR ALL EXCAVATIONS.
4. PHYSICAL AND ELECTRICAL HAZARDS EXIST ANYWHERE INSIDE THE DYNAMIC SAFETY ENVELOPE.
5. COORDINATION WITH EL PASO STREETCAR IS REQUIRED FOR ANY WORK INSIDE THE DSE.

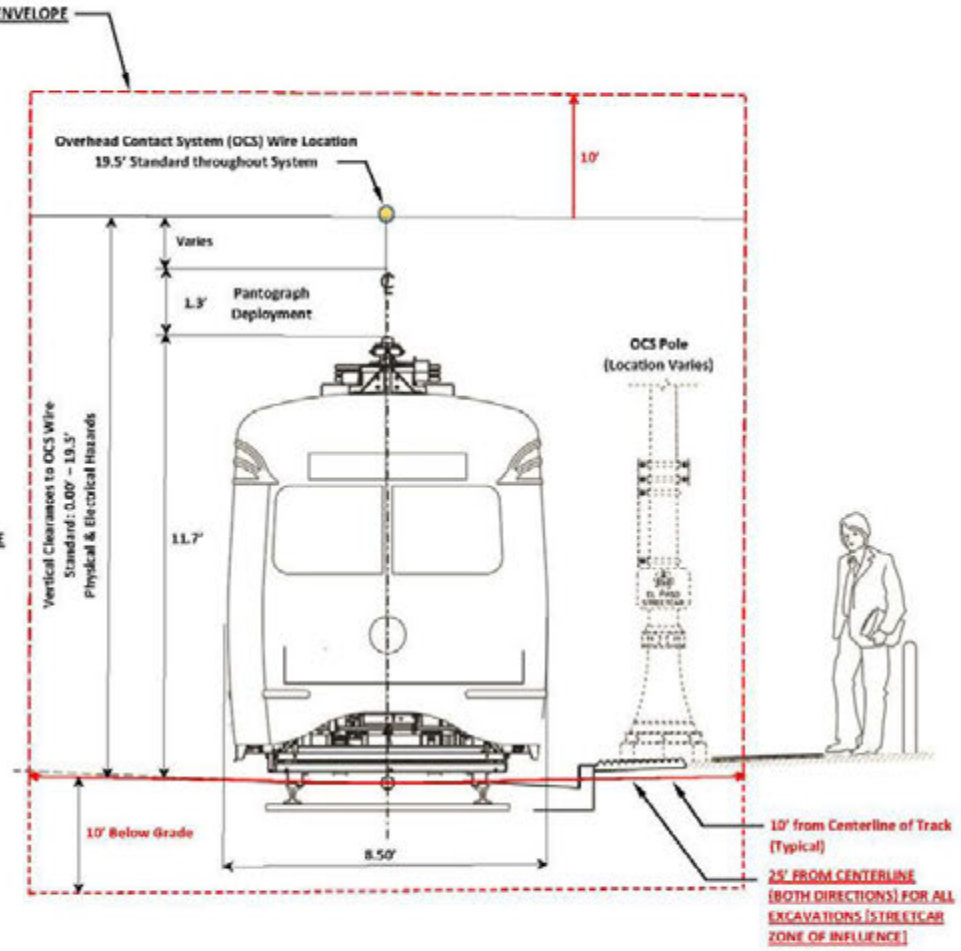

TYPICAL SECTION VIEW – OPERATIONAL RIGHT-OF-WAY / DYNAMIC SAFETY ENVELOPE – SCALE: N.T.S.



Streetcar Information



El Paso Streetcar Vehicle



Length: 46 ft. 6 in

Height: 11 ft. 3 in

Weight: 47,740 lbs.

Capacity: 90-92 passengers

El Paso Streetcar

- 4.8 mile route from the DTC to UTEP
- 27 streetcar stops
- Speeds of up to 35 MPH
- Powered by electricity with overhead wires

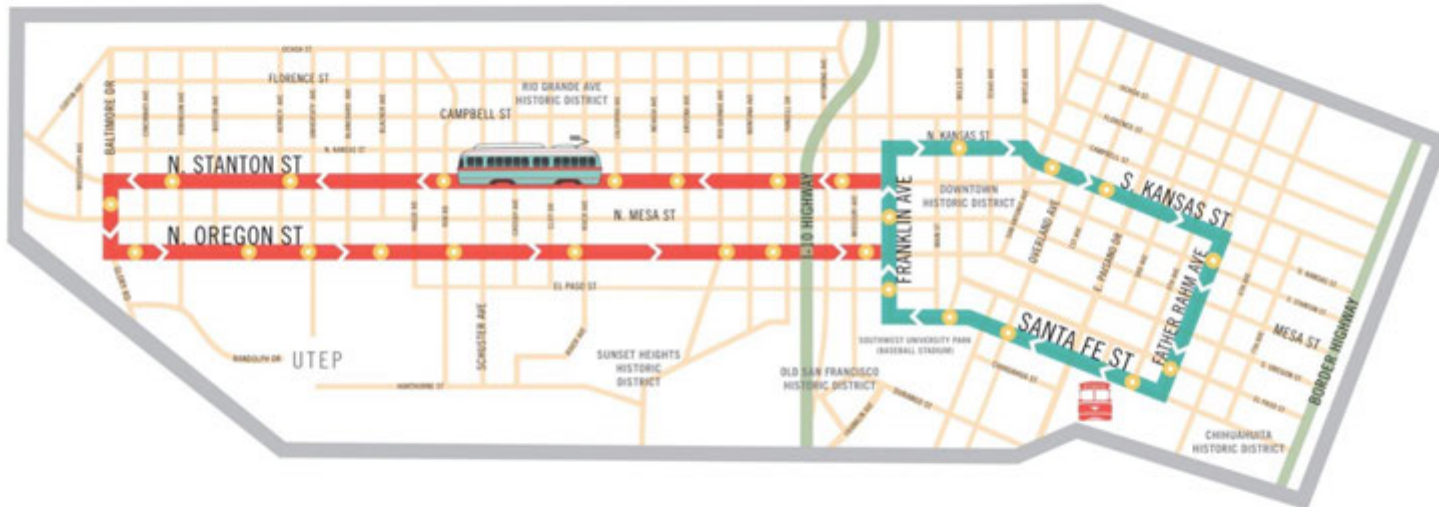

El Paso Streetcar Proposed Schedule

- During Peak Hours, streetcars run every 15 minutes.
- During off Peak Hours, streetcars run every 20 minutes.
- Between 2-3 streetcar vehicles will travel on the route at any given time.



Active Track



An active track is any track which has an Overhead Contact System (OCS) wire is present and capable of running the streetcars for testing or revenue service. El Paso streetcars can run in either direction on any track at any time.



Overhead Contact System (OCS) Wires



- Contact wire is 18' to 20' off the ground with the exception of the pedestrian overpass on N. Oregon south of Hague St where the wire is 15'.
- The 13-kv AC system provides power to the streetcars with 600/650-volt DC power running through the overhead wires.



Revenue Service

- El Paso Streetcar Revenue Service is the period of time when an El Paso Streetcar vehicle is available to the general public and there is an expectation of carrying passengers.



Non-Revenue Service Hours

- Non-Revenue Service Hours refers to the hours outside of the normal revenue service hours as well as the one hour prior to the first revenue service hour of the day.



Streetcar Service Testing



- El Paso Streetcar Service Testing was the period of time when an El Paso Streetcar vehicle was undergoing safety or mechanical testing on the track.
- During this period, the El Paso Streetcar was moving along with traffic but not boarding passengers.
- The El Paso Streetcar is now in full revenue service, operating on city street, and transporting passengers.



El Paso Streetcar

Hours of Operation

Sunday 12:00 pm – 6:00 pm

Mon - Thurs: 7:00 am – 7:00 pm

Friday: 7:00 am – 11:00 pm

Saturday: 12:00 pm – 11:00 pm

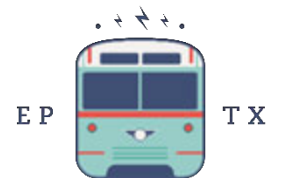

STREETCAR

Track Access Authorization



STREETCAR

Track Access Authorization Process

- <http://www.sunmetro.net/streetcar/track-access>
- Track Access Request Form (either the Special Event or Non-Special Event Application) must be submitted to EPSC within the following deadlines.
 - ✓ *Special Events – 30 calendar days minimum prior to the event.*
 - ✓ *Construction or other non-special event activity – 14 calendar days minimum prior to the start of work.*
 - ✓ *Trenching and/or excavation activity – 45 calendar days minimum prior to the start of work.*



Track Access Authorization Process

Prior to being granted authority to work or conduct a special event within the EPSC Operational ROW, the Permittee is required to:

- 1) Provide a **completed** Track Access Application.
 - Non-Special Events Application
 - Special Events Application
- 2) Provide a Traffic Control Plan in accordance with the Streetcar Specific Typical Applications.
- 3) Submit one (1) copy of Commercial General Liability with Contractual Liability Railroads Endorsement **OR** Railroad Protective Liability Insurance
- 4) Complete a Track Access Training available online through the Track Access Program Policy website: <http://www.sunmetro.net/streetcar/track-access>
Coordinate with Ms. Terri Davila at 915-212-3451 or Teresa.Davila@elpasotexas.gov to pick up Track Access card at the MSF Facility located at 601A Santa Fe.
- 5) Comply with applicable federal, state, local, and EPSC requirements.

FAILURE TO COMPLY WITH THE 14/30/45 – DAY REQUIREMENT WILL RESULT IN AN AUTOMATIC DENIAL OF THE TRACK ACCESS REQUEST APPLICATION.



Non-Special Events Application Checklist

Submission Completeness Checklist: Non-Special Events

REQUIRED DOCUMENTATION FOR STREETCAR TRACK ACCESS PERMIT

- SUBMISSION DEADLINES** – The following deadlines shall apply:
 - Construction, Maintenance, or other Non-Special Event activity – **14 calendar days** minimum prior to the start of work.
 - Trenching and/or Excavation activity – **45 calendar days** minimum prior to the start of work.

- FAILURE TO COMPLY WITH THE 14/45 – DAY REQUIREMENT WILL RESULT IN AN AUTOMATIC DENIAL OF THE TRACK ACCESS REQUEST APPLICATION.**

- TRACK ACCESS TRAINING** – A track access training shall be completed **PRIOR TO** submittal of the Track Access Permit application. A valid ID# shall be required on the application at the time of submission. Please coordinate with Mr. Johnny Balcazar at 915-212-3465 to schedule a training.

- APPLICATION** – Each item on this application shall be completed and all documentation required on this form shall be submitted before this application is accepted for processing, to include all signatures/initials. Submittal of an application does not constitute acceptance for processing until Streetcar staff reviews the application for accuracy and completeness.

- CONSTRUCTION DRAWINGS** – Submit construction drawings of proposed scope of work, if applicable. For maintenance activities, provide detailed description of work in application section 3.0. Refer to the following exhibits for specific submittal requirements:
 - Exhibit H – Trenching and/or Excavations
 - Exhibit I – Aerial Applications (fiber optic, communications, power, etc.)
 - Exhibit J – Directional Boring

- RAIL INSURANCE**- All required insurance shall be submitted with the application as stipulated in Exhibit E of the Track Access Program Policy.

- TRAFFIC CONTROL PLAN** – A traffic control plan shall be submitted with the application as stipulated in Exhibit D of the Track Access Program Policy.



Exhibit A Track Access Request Non-Special Event



1.0 **Date of Submission:** [Redacted]

1.1 **Date(s) of Proposed Work:** [Redacted]

1.2 **Hours of Work:**

From

To

1.3 **Request Type:**

- Construction
- Maintenance
- Other

2.0 **Requestor:** [Redacted]

2.1 **Title:** [Redacted]

2.2 **Company:** [Redacted]

2.3 **Address:** [Redacted]

2.4 **Cell Number:** [Redacted]

2.5 **Email Address:** [Redacted]

2.6 **On-Site Foreman:** [Redacted]

2.7 **Cell Number:** [Redacted]

2.8 **Number of On-Site Workers:** [Redacted]

3.0 **Description of Work:**

[Redacted description of work]

Accela CSNN

[Redacted]

Office Use Only

DOWNTOWN

UPTOWN

EPTC:

[Redacted]

Office Use Only

4.0 **Limit of Access** (describe location of work area, example – Santa Fe from Franklin to Paisano or the intersection of Oregon and University):

5.0 **Do you have a valid Track Access Training ID# ?** Yes, provide ID #:

****A Valid Track Access Training ID# is required at time of application submission, failure to provide a valid ID# will result in an automatic denial of application****

Track Access Training is provided online through the Track Access Program Policy website: <http://www.sunmetro.net/streetcar/track-access>. For information regarding the online training/test, please contact Moraima Cervantes at 915-212-3465.

6.0 **Does your work include the use of a crane, forklift, lifting device, boom truck, scissor lift or similar vehicle?** Yes No

6.1 *If Yes, provide a description of vehicle(s):*

6.2 Vehicle Height*: Vehicle Width: Number of Vehicles: Maximum Reach or Extent of Boom, Crane, Lift:

* Vehicle height measured from ground level to top most element of vehicle.

7.0 **Does your work include the use of a stage, tent, canopy, elevated platform, scaffolding or any temporary structure?** Yes No

7.1 *If Yes, provide a description of structure:*

7.2 Structure Height*: Structure Length: Structure Depth:

* Structure height measured from ground level to top most element.

Acknowledgements

8.0 I [redacted] (the "Applicant") understand that any encroachment into the Streetcar Operational Right-of-Way will require Streetcar Specific Temporary Traffic Control and the use of a Streetcar Flagger (if during revenue-service hours), as referenced in Exhibit D. I also understand that an approved Traffic Control Plan (TCP) or Pedestrian Control Plan (PCP) will also be required and that all flaggers and signage meet Texas Department of Transportation (TxDOT) standards incorporated in the most recent edition of the Texas Manual on Uniform Traffic Control Devices (TMUTCD). Furthermore, I understand that the City of El Paso will not furnish a Streetcar Flagger on my behalf, and that it is the sole responsibility of the applicant to contract with a traffic control provider. [redacted] (initials)

8.1 I understand when there exists multiple permits, or requests for access to the ROW it shall be the policy of EPSC to accept/process requests on a first come, first serve basis. Only one (1) Permittee may occupy the same requested portion of the ROW at a time, subsequent requests for the use of an already allocated portion of the ROW will be denied regardless of permission obtained from other COEP departments, contractors, vendors, or other regulatory entity. [redacted] (initials)

8.2 I understand that I must provide insurance as a condition of this permit application in accordance with Exhibit E. [redacted] (initials)

Applicant will coordinate with applicable City Departments, state, or federal agencies to obtain any necessary permits and approvals required for the proposed work and use of premises.

Applicant releases the City of El Paso ("City"), the Mass Transit Department for the City of El Paso ("MTD") and the City's and MTD's officers, employees, and agents from any liability and claims for illness, injuries, death, property damage, and/or property loss sustained by Applicant as a result of any inaction or action by the Applicant or third party on the public right-of-way.

APPLICANT AGREES, TO THE FULLEST EXTENT ALLOWED BY LAW, TO INDEMNIFY, DEFEND, AND HOLD HARMLESS THE CITY OF EL PASO (THE "CITY"), THE MASS TRANSIT DEPARTMENT FOR THE CITY OF EL PASO ("MTD") AND THE CITY'S AND MTD'S OFFICERS, AGENTS, AND EMPLOYEES FROM AND AGAINST ANY AND ALL CLAIMS, SUITS, ACTIONS JUDGEMENTS, FINES, PENALTIES, LOSS, DAMAGE, COST, OR EXPENSE (INCLUDING BUT NOT LIMITED TO ATTORNEYS' FEES), WHETHER DIRECT OR INDIRECT, DUE TO BODILY OR PERSONAL INJURY, DEATH, SICKNESS, PROPERTY DAMAGE, OR PROPERTY LOSS ARISING OUT OF APPLICANT'S ACTIONS OMMISIONS, AND/OR ACTIVITIES. IN THE EVENT A THIRD PARTY MAKES A CLAIM OR FILES A LAWSUIT AGAINST THE CITY AND/OR MTD FOR ANYTHING RELATED TO APPLICANT'S ACTIONS, OMMISIONS, OR ACTIVITIES, THE APPLICANT SHALL DEFEND SUCH CLAIM OR LAWSUITS ON BEHALF OF THE CITY AND/OR MTD AT APPLICANT'S SOLE COST AND EXPENSE. APPLICANT FURTHER AGREES TO REPAIR ANY DAMAGE OR DISTURBANCE TO CITY AND/OR MTD PROPERTY CAUSED BY THE APPLICANTS. APPLICANT AGREES THAT FOR PURPOSES OF THIS PROVISION THE ACTIONS, OMISSIONS, AND/OR ACTIVITIES INCLUDE THOSE OF THE APPLICANT'S AGENTS, EMPLOYEES, OFFICERS, CONTRACTORS, AND SUBCONTRACTORS.

ACKNOWLEDGEMENT: I attest that this application is complete and accurate to the best of my knowledge. I understand that any inaccurate or incomplete information provided on this application may delay or be cause for denial of the Track Access Permit. Furthermore, I attest that I have read, fully understand, and accept all conditions and requirements of the Track Access Program Policy.

8.4 Applicant Name: [redacted]

8.5 Applicant Signature: [redacted] Date: [redacted]

Submit Completed Applications through the City of El Paso Online Permitting System:

<https://epermits.elpasotexas.gov/CitizenAccess/Default.aspx>

Special Events Application Checklist

Submission Completeness Checklist: Special Events

REQUIRED DOCUMENTATION FOR STREETCAR TRACK ACCESS PERMIT

- SUBMISSION DEADLINES** – The following deadlines shall apply:
 - Special Event activity – **30 calendar days** minimum prior to the start of the event.
- FAILURE TO COMPLY WITH THE 30 – DAY REQUIREMENT WILL RESULT IN AN AUTOMATIC DENIAL OF THE TRACK ACCESS REQUEST APPLICATION.**
- TRACK ACCESS TRAINING** – A track access training shall be completed **PRIOR TO** submittal of the Track Access Permit application. A valid ID# shall be required on the application at the time of submission. Please coordinate with Mr. Johnny Balcazar at 915-212-3465 to schedule a training.
- APPLICATION** – Each item on this application shall be completed and all documentation required on this form shall be submitted before this application is accepted for processing, to include all signatures/initials. Submittal of an application does not constitute acceptance for processing until Streetcar staff reviews the application for accuracy and completeness.
- SITE PLAN/MAP** – Submit a site plan or map detailing the event limits or route for any “moving” events.
- RAIL INSURANCE**- All required insurance shall be submitted with the application as stipulated in Exhibit E of the Track Access Program Policy.
- TRAFFIC CONTROL PLAN** – A traffic control plan shall be submitted with the application as stipulated in Exhibit D of the Track Access Program Policy.



Exhibit A1 Track Access Request - Special Event



- 1.0 Date of Submission:
- 1.1 Date of Event:
- 1.2 Hours of Event: From To

Accela CSSN

Office Use Only

DOWNTOWN UPTOWN

CSEV:

Office Use Only

- 2.0 Requestor:
- 2.1 Title:
- 2.2 Company:
- 2.3 Address:
- 2.4 Cell Number:
- 2.5 Email Address:

- 3.0 Description of Event:
-
-
-

- 4.0 Number of Participants:

- 5.0 Limit of Access (describe location of event area, example – Santa Fe from Franklin to Paisano or the intersection of Oregon and University):

- 6.0 Do you have a valid Track Access Training ID# ? Yes, provide ID #:

****A Valid Track Access Training ID# is required at time of application submission, failure to provide a valid ID# will result in an automatic denial of application****

Track Access Training is provided online through the Track Access Program Policy website:
<http://www.sunmetro.net/streetcar/track-access>. For information regarding the online training/
 test, please contact Terri Davila at 915-212-3451.



STREETCAR

7.0 Is your Special Event considered a "Moving" Special Event? (i.e., Walk, Run, Marathon, March, Parade)

Yes No

If yes, Streetcar Specific Temporary Traffic Control as referenced in Exhibit D, Typical Applications is required at time of application submission. Failure to provide a Traffic Control Plan will result in an automatic denial of application.

8.0 Does your event include the use of vehicles or parade floats? Yes No

8.1 *If Yes, provide a description of vehicle(s):*

8.2 Vehicle Height*: _____ Vehicle Width: _____ Number of Vehicles: _____

* Vehicle height measured from ground level to top most element of vehicle or float.

9.0 Does your event include the use of a stage, tent, canopy, elevated platform, or any temporary structure? Yes No

9.1 *If Yes, provide a description of structure:*

9.2 Structure Height*: _____ Structure Length: _____ Structure Depth: _____

* Structure height measured from ground level to top most element.

Acknowledgements

10.0 I, _____ (the "Applicant") understand that any encroachment into the Streetcar Operational Right-of-Way will require Streetcar Specific Temporary Traffic Control and the use of a Streetcar Flagger (if during revenue-service hours), as referenced in Exhibit D. I also understand that an approved Traffic Control Plan (TCP) or Pedestrian Control Plan (PCP) will also be required and that all flaggers and signage meet Texas Department of Transportation (TxDOT) standards incorporated in the most recent edition of the Texas Manual on Uniform Traffic Control Devices (TMUTCD). Furthermore, I understand that the City of El Paso will not furnish a Streetcar Flagger on my behalf, and that it is the sole responsibility of the applicant to contract with a traffic control provider. _____ (initials)

10.1 I understand when there exists multiple permits, or requests for access to the ROW it shall be the policy of EPSC to accept/process requests on a first come, first serve basis. Only one (1) Permittee may occupy the same requested portion of the ROW at a time, subsequent requests for the use of an already allocated portion of the ROW will be denied regardless of permission obtained from other COEP departments, contractors, vendors, or other regulatory entity. _____ (initials)

10.3 I understand that I must provide insurance as a condition of this permit application in accordance with Exhibit E. _____ (initials)

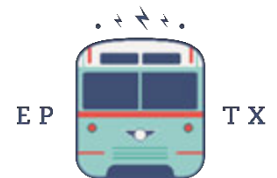

STREETCAR

Applicant will coordinate with applicable City Departments, state, or federal agencies to obtain any necessary permits and approvals required for the proposed work and use of premises.

Applicant releases the City of El Paso ("City"), the Mass Transit Department for the City of El Paso ("MTD") and the City's and MTD's officers, employees, and agents from any liability and claims for illness, injuries, death, property damage, and/or property loss sustained by Applicant as a result of any inaction or action by the Applicant or third party on the public right-of-way.

APPLICANT AGREES, TO THE FULLEST EXTENT ALLOWED BY LAW, TO INDEMNIFY, DEFEND, AND HOLD HARMLESS THE CITY OF EL PASO (THE "CITY"), THE MASS TRANSIT DEPARTMENT FOR THE CITY OF EL PASO ("MTD") AND THE CITY'S AND MTD'S OFFICERS, AGENTS, AND EMPLOYEES FROM AND AGAINST ANY AND ALL CLAIMS, SUITS, ACTIONS JUDGEMENTS, FINES, PENALTIES, LOSS, DAMAGE, COST, OR EXPENSE (INCLUDING BUT NOT LIMITED TO ATTORNEYS' FEES), WHETHER DIRECT OR INDIRECT, DUE TO BODILY OR PERSONAL INJURY, DEATH, SICKNESS, PROPERTY DAMAGE, OR PROPERTY LOSS ARISING OUT OF APPLICANT'S ACTIONS OMMISIONS, AND/OR ACTIVITIES. IN THE EVENT A THIRD PARTY MAKES A CLAIM OR FILES A LAWSUIT AGAINST THE CITY AND/OR MTD FOR ANYTHING RELATED TO APPLICANT'S ACTIONS, OMMISIONS, OR ACTIVITIES, THE APPLICANT SHALL DEFEND SUCH CLAIM OR LAWSUITS ON BEHALF OF THE CITY AND/OR MTD AT APPLICANT'S SOLE COST AND EXPENSE. APPLICANT FURTHER AGREES TO REPAIR ANY DAMAGE OR DISTURBANCE TO CITY AND/OR MTD PROPERTY CAUSED BY THE APPLICANTS. APPLICANT AGREES THAT FOR PURPOSES OF THIS PROVISION THE ACTIONS, OMISSIONS, AND/OR ACTIVITIES INCLUDE THOSE OF THE APPLICANT'S AGENTS, EMPLOYEES, OFFICERS, CONTRACTORS, AND SUBCONTRACTORS.

ACKNOWLEDGEMENT: I attest that this application is complete and accurate to the best of my knowledge. I understand that any inaccurate or incomplete information provided on this application may delay or be cause for denial of the Track Access Permit. Furthermore, I attest that I have read, fully understand, and accept all conditions and requirements of the Track Access Program Policy.

10.4 Applicant Name:

10.5 Applicant Signature: _____ Date:

**Submit Completed Applications through the City of El Paso
Online Permitting System:**

<https://epermits.elpasotexas.gov/CitizenAccess/Default.aspx>



REETCAR

Track Access Authorization Process

- Once the permit has been approved, the permittee will submit the Track Allocation Form two (2) weeks before the work or special event along the Streetcar corridor, Streetcar Dynamic Safety Envelope, or Operational Right-of-way.
- To submit your Application for a Permit and to take the Track Access Training please go to: <https://sunmetro.net/streetcar/track-access/>
- It is required that the applicant participate in the Track Access Training prior to the submission of an access request. Once you complete the Track Access Training, you will be notified when your Track Access Card is ready to be picked up. For further information regarding training please contact:

Terry Davila – El Paso Streetcar 915-212-3451

Teresa.Davila@elpasotexas.gov

- It is the responsibility of the Permittee requesting **TO CONDUCT A SPECIAL EVENT OR WORK ON, UNDER, ACROSS, OR OVER** the EPSC Operational ROW and the related infrastructure, to coordinate with EPSC prior to any work or event.



Track Access Request Form



Track Allocation Notification Form

Track Access Permit Number _____

Date of submission: _____

Requested date _____

Permit holder _____

Description of Work: _____

Number of Workers: _____ Hours of access

From	To

Limit of access

Street intersection

From: _____ To: _____

Street

From: _____ To: _____

Trained Permittee field worker(s) Certified by Streetcar Operator Yes No

Power Down/Removal During Non-Revenue Service Hours Requested: Yes No

Power Down/Removal During Revenue Service Hours Requested: Yes No

Spotter required Yes No

Assigned Spotter _____

Attachment Enclosed: _____

Special Operating Conditions:

1. Work within 10 feet of the Overhead Contact System requires line deactivation; any continuous work within its Envelope of Operation requires shutdown of service. Efforts must be made to schedule such work during non-operational hours unless due to emergency or major coordinated work .
2. Request for Right-of-Way access permit must be submitted by 12:00 p.m. (daily), 48 hours prior to the scheduled work.
3. All personnel must wear reflective safety garments conforming to 1988 Edition, MUTCD Sec. 6E-3, High-Visibility Clothing.

El Paso Streetcar Map

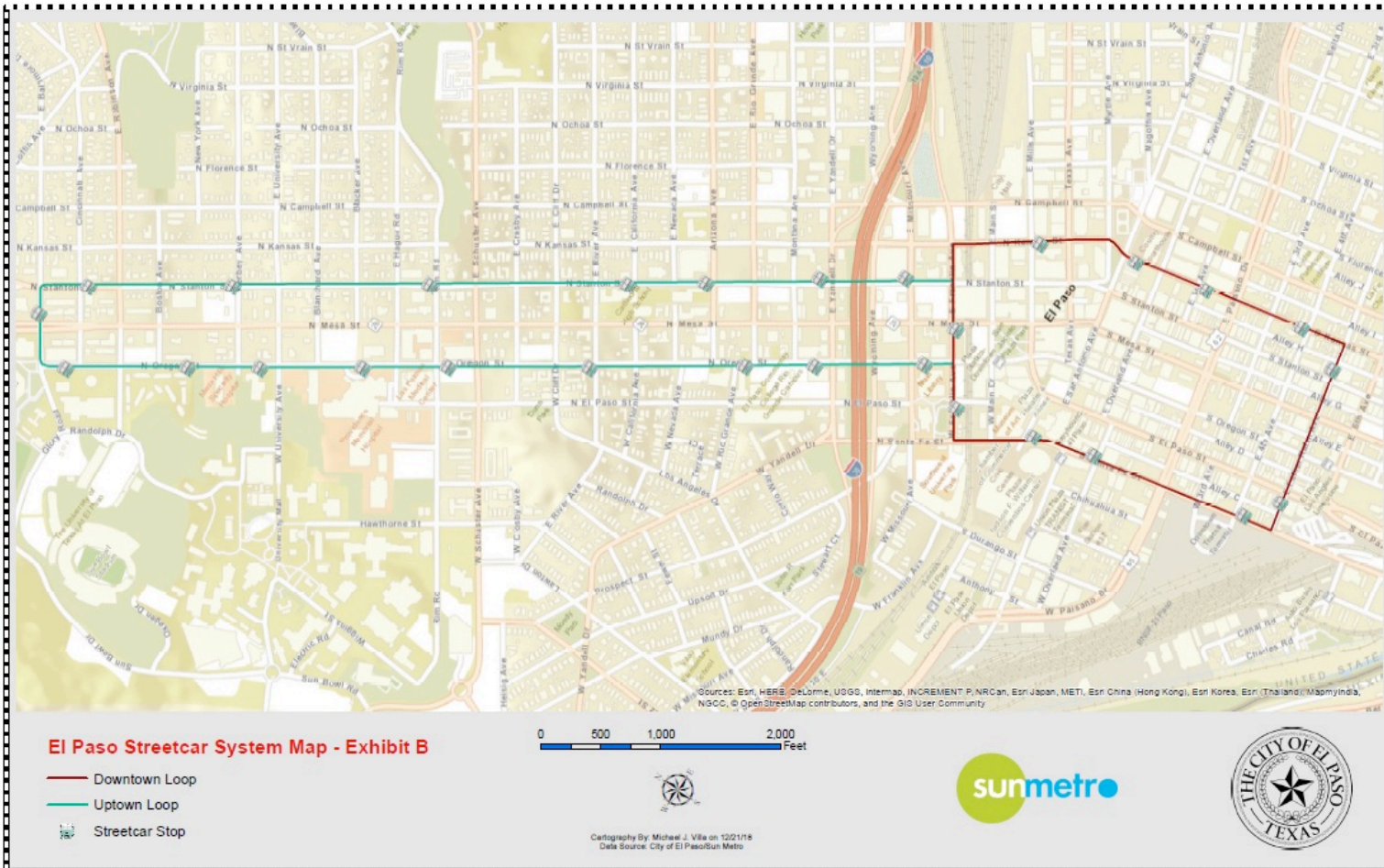

Components of Temporary Traffic Control

Figure 6C-1. Component Parts of a Temporary Traffic Control Zone

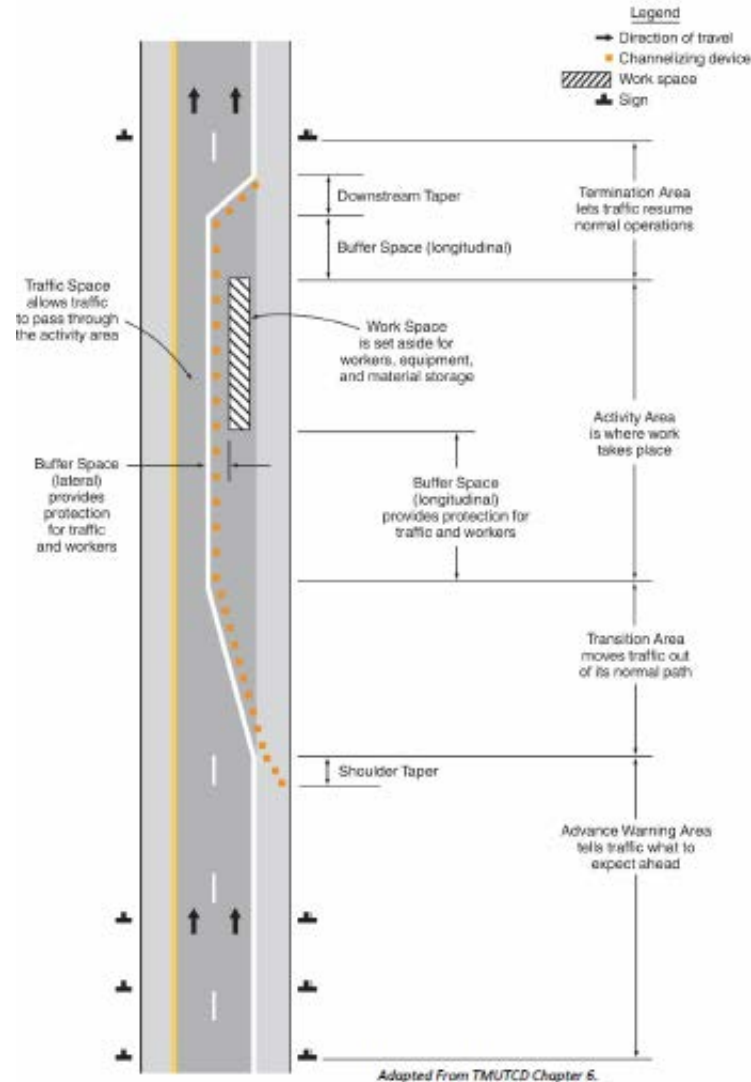

Track Access Authorization Process

5. *Emergency Access*

- 5.1 Emergency Access will be granted on a case-by-case basis in accordance with the provisions outlined in this policy. The Chief Safety Officer shall have the sole responsibility in granting emergency access.
- 5.2 Request for emergency access shall be routed to Streetcar Dispatch at **915-212-3454** or **915-212-3425** [After Hours].
- 5.3 Submittal requirements (see section 2.9 for definitions):
- Tier 1 – Documented written or verbal description of the emergency;
 - Tier 2 or 3 – Track Access Request Form **AND** Traffic Control Plan.
- 5.4 All work for Tier 2 or Tier 3 activities shall only be performed during non-revenue service hours.
- 5.5 Emergency Access will be granted for a period of **5 calendar days maximum**, after which time the permittee shall submit a Track Access Request and provide all required documentation in accordance with the provisions outlined in this policy.





CITY OF EL PASO - STREETCAR
TRACK ACCESS PERMIT
CSNN23-00007

Permitee:

Robert Downey Jr.
8516 EDGAR PARK AVE. EL PASO,
TX 79904

On-Site POC:

Mr. Robert Downey Jr.
915-222-2222

Issued:

Permit Type: Construction

Work Site Location: UPPER & LOWER LOOPS

Description of Permitted Work: Approved Construction work with conditions as outlined in Streetcar Track Access Permit

Valid From: 04/24/2023

Valid To: 05/24/2023

Military Time: 08:00 - 16:00

Streetcar Notes:

Please keep in mind:

MON-TUES – Work can be done all day, unless testing is taking place, which is 2nd week of every month.

WED-FRI – Work can be done only up until 11:00 a.m. & as early as needed. SAT & SUN - No work allowed.

YOU MUST NOTIFY STREETCAR DISPATCH 30 MINUTES PRIOR TO ENTERING RIGHT-OF WAY (ROW), AND WHEN EXITING THE ROW at (915) 212-3454 OR (915)212-3425.

*** NOTICE ***

1. PERMITTEE AGREES, TO THE FULLEST EXTENT ALLOWED BY LAW, TO INDEMNIFY, DEFEND, AND HOLD HARMLESS THE CITY, MTD AND THE CITY'S AND MTD'S OFFICERS, AGENTS, AND EMPLOYEES FROM AND AGAINST ANY AND ALL CLAIMS, SUITS, ACTIONS, JUDGMENTS, FINES, PENALTIES, LOSS, DAMAGE, COSTS, OR EXPENSE (INCLUDING BUT NOT LIMITED TO ATTORNEYS' FEES), WHETHER DIRECT OR INDIRECT, DUE TO BODILY OR PERSONAL INJURY, DEATH, SICKNESS, PROPERTY DAMAGE, OR PROPERTY LOSS ARISING OUT OF PERMITTEE'S ACTIONS, OMISSIONS, AND/OR ACTIVITIES. IN THE EVENT A THIRD PARTY MAKES A CLAIM OR FILES A LAWSUIT AGAINST THE CITY AND/OR MTD FOR ANYTHING RELATED TO PERMITTEE'S ACTIONS, OMISSIONS, OR ACTIVITIES, THE PERMITTEE SHALL DEFEND SUCH CLAIM OR LAWSUITS ON BEHALF OF THE CITY AND/OR MTD AT PERMITTEE'S SOLE COST AND EXPENSE. PERMITTEE FURTHER AGREES TO REPAIR ANY DAMAGE OR DISTURBANCE TO CITY AND/OR MTD PROPERTY CAUSED BY PERMITTEE.
2. THIS PERMIT IS ISSUED IN ACCORDANCE WITH THE PROVISIONS OF THE EL PASO STREETCAR TRACK ACCESS PROGRAM AND THE PERMITTEE, IN ACCEPTING IT, OBLIGATES THEM TO COMPLY FULLY WITH ALL PROVISIONS OF THE TRACK ACCESS PROGRAM AND OTHER APPLICABLE CODES AND ORDINANCES INSOFAR AS THEY AFFECT THIS PERMIT.
3. THIS TRACK ACCESS PERMIT, APPROVED TRACK ACCESS REQUEST FORM, AND APPROVED TRAFFIC CONTROL PLAN, OR A COPY THEREOF, SHALL BE KEPT ON THE WORK SITE OR IN THE POSSESSION OF THE ABOVE NAMED PERMITTEE UNTIL COMPLETION OF ALL WORK OR EVENT.
4. EL PASO STREETCAR MUST APPROVE ANY CHANGES IN PERMITTEE OR DEVIATION FROM APPROVED PLANS.
5. THIS PERMIT IS ONLY VALID FOR THE DATES AND TIMES SPECIFIED.
6. THIS PERMIT MAY BE REVOKED FOR VIOLATION OF ANY OF THE ABOVE PROVISIONS AND/OR ALL OTHER APPLICABLE LAWS.
7. PERMITTEE, IN ACCEPTING THIS PERMIT ACKNOWLEDGES THEY HAVE READ THIS PERMIT AND STATE THAT THE ABOVE INFORMATION IS CORRECT, AND AGREE TO COMPLY WITH ALL CITY, STATE, AND FEDERAL LAWS REGULATING ACTIVITIES COVERED BY THE PERMIT.

Issued By: Teresa Davila

Communication

- Permittee **MUST** contact El Paso Streetcar Dispatch at least 30 minutes prior to entering the ROW, and when exiting the ROW
- El Paso Streetcar Dispatch is located at 601-A Santa Fe Street, El Paso, TX 79901
- El Paso Streetcar Dispatch phone number(s):
915-212-3460
915-212-3461
915-212-3454
- After hours Sun Metro Dispatch can be reached at
915-212-3425



Authority

- Ordinance 018824 section 13.42.020 (D) establishes that:
 - For purposes of protecting the health, safety, and welfare of all citizens, the Streetcar Safety Officer is authorized **to issue a stop work order** to any activity that does not comply with this chapter and/or the Track Access Program Procedure
- Ordinance 018824 section 13.42.030 (A-B) establishes that:
 - A. Any person who shall violate any provision of this chapter shall, upon conviction, be guilty of a misdemeanor and punished by a fine not **exceeding five hundred dollars**. Each day the violation occurs shall constitute a separate offense.
 - B. The Streetcar Safety Officer, the permit official, and any code enforcement officer of the City of El Paso are authorized to enforce the provisions of this chapter and shall have the power to issue misdemeanor citations to any person violating the provisions of this chapter.



Streetcar Safety Rules



Respect The Rail

- You MUST complete this training before you enter any Work or Special Event Area!
- You MUST read, understand and formally acknowledge all procedures before you can enter a Work/Special Event Area!
- You MUST have a valid permit to work in the specified Work Area or conduct a Special Event!



Respect The Rail

- You **MUST NEVER** enter the Work Zone / Special Event Area without prior authorization!
- You **MUST** utilize **Qualified Flaggers** when working in the Operational Right-of-Way during revenue service and/or testing!
- No work other than that specified in the Track Access Request Form and Permit is authorized.



Respect The Overhead Contact Wire

- ALWAYS consider that the Overhead Wires are energized and **HOT!**



Respect The Rail

- Remain clear of passing streetcars.
- Always look both ways before crossing tracks!
- Always exercise caution when moving out of a work area and into an active street.
- Always be vigilant for streetcar movement.

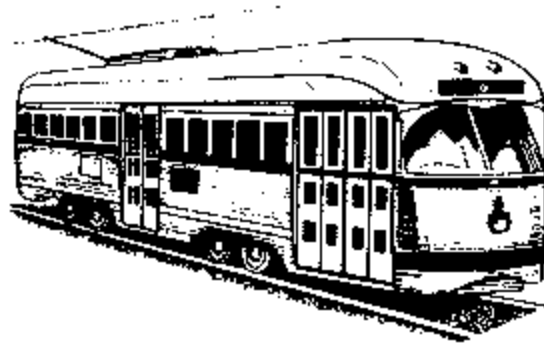

Respect The Rail



EP TX
STREETCAR

Respect The Rail

- All Contractors and construction crew members **MUST** have a Supervisor present.
- Inform the Supervisor on entering and leaving the work area.
- The Supervisor must possess all necessary City permits and authorizations on his / her person at all times.
- The Supervisor must explain all conditions of permits to the crew before beginning the work.
- All workers must comply with the requirements and terms of the Track Access Authorization.



Respect The Rail

- The Supervisor must ensure all appropriate signs are properly deployed marking the work area.
 - Rubber tired vehicles may not be present on energized track without special permission.
 - Never swing equipment over or under overhead wires closer than 10 feet.
- ✓ Special request needed for exceptions to this rule.



Respect the Rail

- **Always be alert** – streetcars are quiet, fast and can travel in either direction on any track!
- Streetcars cannot stop quickly.
- Pay strict attention to the Flagger's signals.
- Never loiter on or near active tracks.



Precautions while working

- Stay out of the work zone area unless your job requires you to enter the area.
- Reflective safety vests and Personal Protection Equipment (PPE) appropriate for the work MUST be worn at all times.
- If work is being done during a power down, grounds may need to be installed
- It is the responsibility of the permit holder to make sure all permit workers follow the procedures accordingly



PERSONAL PROTECTIVE EQUIPMENT

Every person on the ROW shall have the following PPE

Reflective high visibility vest



Flashlight
(if is night work)

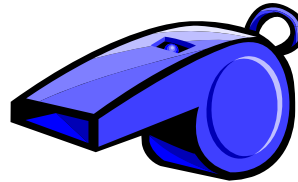

whistle
and/or air horn



Safety shoes/boots



<i>ROW</i>	No.
Name:	
Badge # or Company:	
Date of Training:	
Expiration Date:	
Valid with Photo ID / Not Proof of Employment Massachusetts Bay Transportation Authority	

Valid ROW
Safety
Certification

When a streetcar approaches...

- Never stand between sets of tracks, or between tracks, particularly on a curve or at points of restricted clearance.
- Use caution if stepping into active street adjacent to the tracks.



What is a Flagger?

- A Flagger, provided by the Track Access permit holder, will be assigned to each work crew, to protect the members of that crew when working near the streetcar and when streetcar movement is expected.
- Cost for Flaggers will be the sole responsibility of the permit holder.



Flaggers

Figure 6E-3. Use of Hand-Signaling Devices by Flaggers

PREFERRED METHOD
STOP/SLOW Paddle

EMERGENCY SITUATIONS ONLY
Red Flag

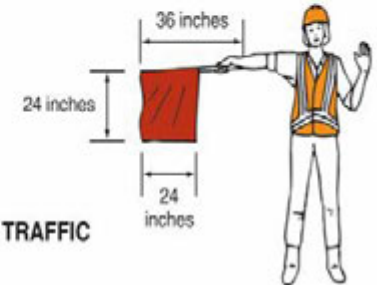

Hand Signals for Flaggers

	<u>INDICATION</u>
Swung at Right angle to the track	STOP AND STAY
Slight vertical movement, at arms-length, at Right angle to the track	REDUCE SPEED
Raised and lowered Vertically	PROCEED
Unclear hand signal, Or arms being waved Frantically	STOP

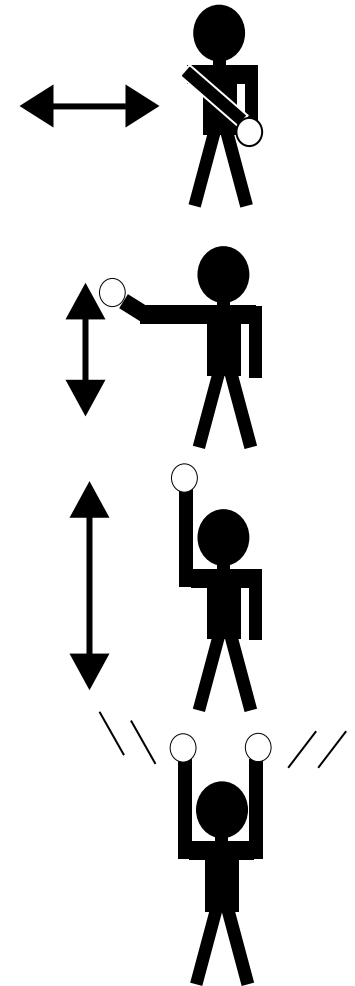



WORK ZONE / REDUCE SPEED AREA



A Flagger is...

- A work crew member meant to protect all workers in the work party.
- Flaggers are dedicated to streetcar safety, vehicles, and pedestrian control.
- Flaggers stations and all Temporary Traffic Control (TTC) shall be in strict accordance with the most recent edition of Texas Manual on Uniform Traffic Control Devices (TMUTCD).



ACTIVITIES ON THE RIGHT OF WAY (ROW)



Crane Activities

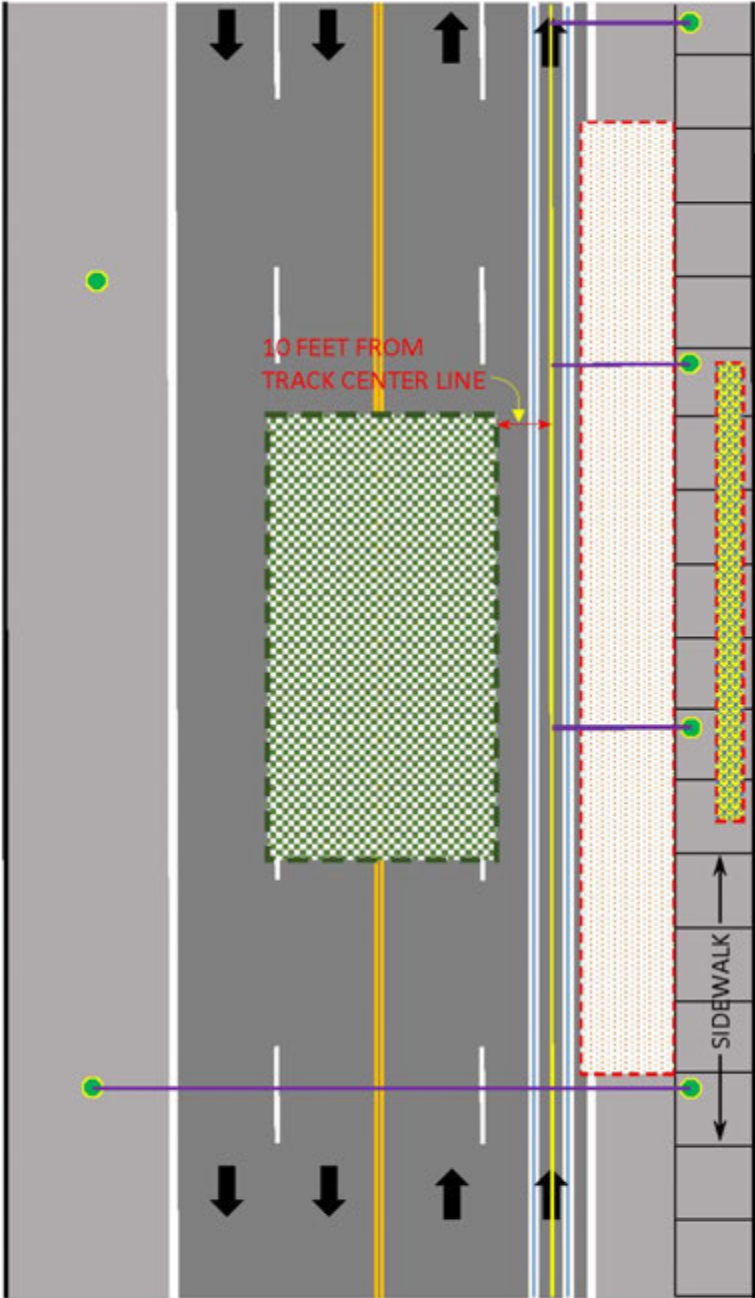

CRANE STAGING ZONES

SYMBOL LEGEND

- Direction of Traffic
- Crane Staging Permissible
- Crane Staging NOT Permissible
- Streetcar Tracks
- OCS Wire
- OCS Pole
- OCS Wire Appurtenance
- Scissor Lift Permissible*

Crane staging shall only be permissible in the GREEN hatched area. Staging area size and location varies. Crane staging is NOT permissible on roadway shoulder closest to tracks, underneath the Overhead Contact System (OCS) Wire, or under/between any OCS Pole or Appurtenance.

** = Scissor Lift Permissible on sidewalk ONLY under certain circumstances on a case-by-case basis, subject to the approval of El Paso Streetcar.*

Crane shall also mean any aerial lift system or vehicle capable of carrying people or equipment.



STREETCAR

Crane Activities

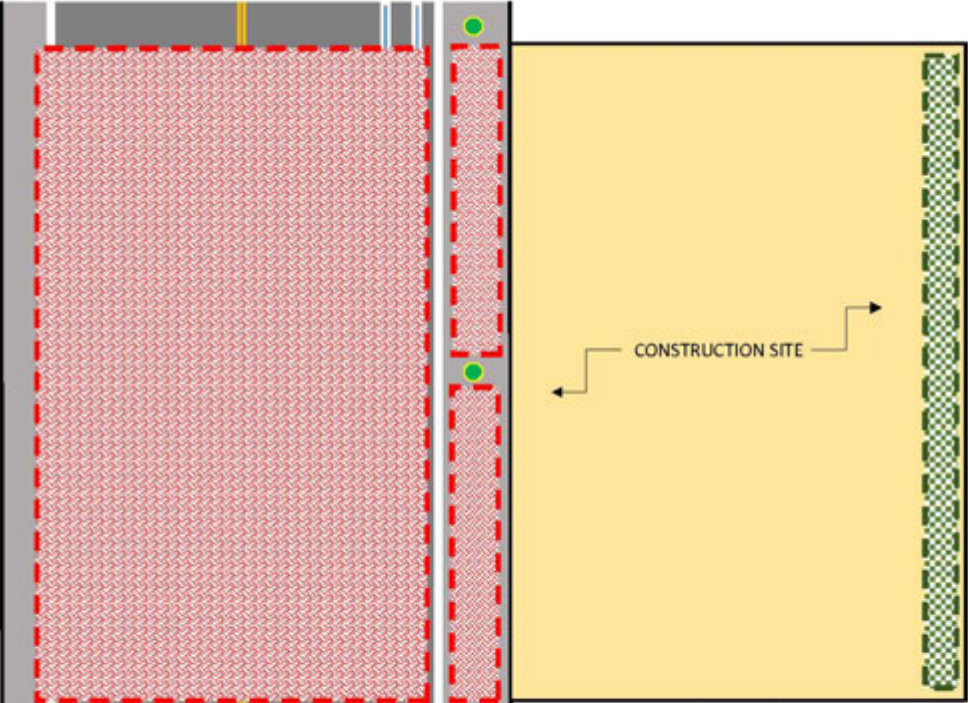

SYMBOL LEGEND

-  Tower Crane Placement Permitted
-  NO Loading Zone
-  Streetcar Tracks
-  OCS Pole

Tower crane placement shall be situated on opposite end of construction site property, at a location furthest away from streetcar tracks. Crane equipment staging or loading/unloading of materials is NOT permissible on roadway, shoulder, sidewalk, or underneath the Overhead Contact System (OCS) Wire, or under/between/over any OCS Pole or Appurtenance.

TOWER CRANE PLACEMENT STANDARDS



STREETCAR

SUBMITTAL REQUIREMENTS

Streetcar Zone of Influence

El Paso Streetcar has identified minimum trench safety and excavation requirements for all proposed open trenching or excavations within 25 feet of the track centerline (Streetcar Zone of Influence). Specific design requirements are detailed in Figure H – 1.

General

All drawings and calculations for open trenching shall be prepared, sealed and signed by a Professional Engineer (civil or structural) currently licensed in the State of Texas who has previous experience in the design of trench safety applications.

The designer will be responsible for the accuracy of all controlling dimensions as well as the selection of appropriate materials and systems that accurately reflect the actual field conditions. No open trenching installation within the Streetcar Zone of Influence (25 feet from track centerline) will be allowed until the drawings and calculations are reviewed and accepted by EPSC.

Submittal of forms, drawings and calculations shall be provided to EPSC for review in electronic format transmitted by email, or mail (with CD-R or DVD-R properly labeled). Files shall be Adobe PDF compatible. Each separate document shall be a separate PDF file (drawings, specifications, calculations, forms, etc.).

All submittals, design calculations, specifications and drawings shall be prepared in accordance with a QA/QC process. The QA/QC process may follow the established program of EPSC, Engineer in Responsible Charge firm, or Permittee. At a minimum, the QA/QC process must consist of an independent check of design calculations and an independent QC review of the drawings and specifications prior to submittal to EPSC by qualified individuals. Documentation of the QA/QC process, including names and contact information of independent reviewers, shall be made available to EPSC at their request.

A minimum of **FIFTEEN (15) CALENDAR DAYS** should be allowed for EPSC's review, provided that all required submittal materials are included and properly identified.

Requirements

Specific requirements concerning open trenching are detailed in Exhibit H1 – Excavation Support Guidelines which are available for download on Sun Metro's website www.sunmetro.net/streetcar.

Trenching

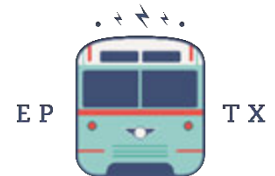

STREETCAR

Trenching

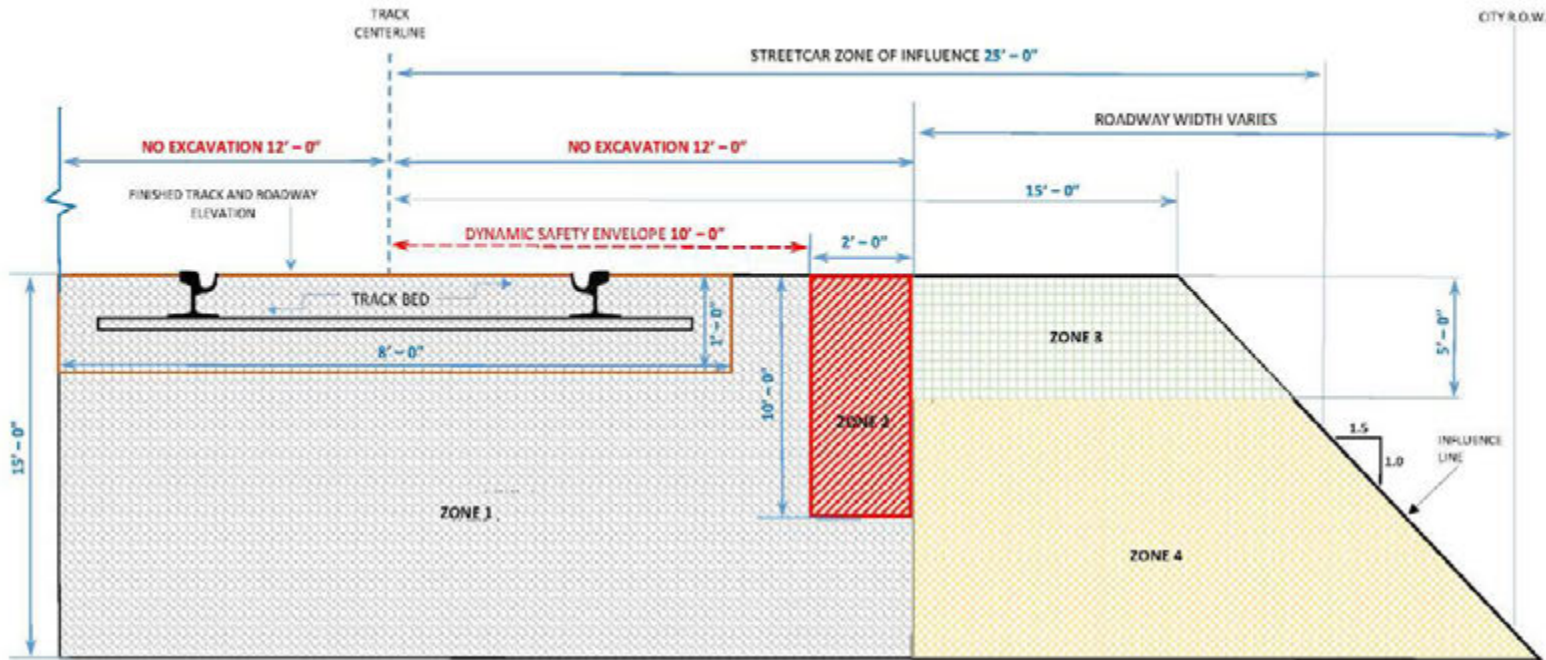

TYPICAL SECTION VIEW - STREETCAR TRENCH ZONES- SCALE: N.T.S.

GENERAL NOTES:

- CROSS - SECTION SHOWN IS TYPICAL OF FIELD CONDITIONS FOUND ON STREETCAR OPERATIONAL RIGHT-OF-WAY (ALIGNMENT).
- A CONCRETE TRACK BED TYPICALLY MEASURING 8 FEET IN WIDTH AND 12 INCHES IN DEPTH (FROM FINISHED ROADWAY ELEVATION) IS FOUND THROUGHOUT THE ALIGNMENT.
- HMAC OR CONCRETE ROADWAY PAVEMENT OR A COMBINATION OF BOTH MAY BE FOUND ON EITHER SIDE OF TRACK BED AT VARIOUS DEPTHS.
- AN 8 INCH COMPACTED BASE IS TYPICAL UNDERNEATH THE ADJACENT HMAC OR CONCRETE PAVEMENT.
- A 12 INCH COMPACTED BASE IS TYPICAL UNDERNEATH THE TRACK BED.
- SUBGRADE DEPTH VARIES THROUGHOUT THE ALIGNMENT.
- ZONE 1** - EXCAVATION IS PROHIBITED.
- ZONE 2** - NO EXCAVATION OR TEMPORARY SHORING INSTALLATION WILL BE ALLOWED WITHOUT THE SPECIAL WRITTEN PERMISSION OF EL PASO STREETCAR (EPSC). ALTERNATES TO SHORED EXCAVATIONS SHALL BE UTILIZED WHEN PRACTICAL. IF EPSC GRANTS A VARIANCE TO ALLOW EXCAVATION, VERTICAL EXCAVATION WITH CONTINUOUS SHORING WALLS IS REQUIRED. SHORING INSTALLATION SHALL BE COMPLETE PRIOR TO ANY EXCAVATION. DESIGN OF THE SHORING SYSTEM SHALL INCLUDE LATERAL SURCHARGE DUE TO STREETCAR LIVE LOAD.
- ZONE 3** - EXCAVATION REQUIRES TEMPORARY SHORING. LATERAL SURCHARGE DUE TO STREETCAR LIVE LOAD NEED NOT BE CONSIDERED IN SHORING DESIGN. THE EXCAVATION SHALL BE PROVIDED WITH A SHORING SYSTEM THAT ACTIVELY SUPPORTS THE SIDES OF THE EXCAVATION AND PREVENTS THE EXCAVATION FACES FROM UNRAVELING OR MOVING. SLOPED EXCAVATIONS ARE NOT PERMITTED.
- ZONE 4** - EXCAVATION REQUIRES TEMPORARY SHORING. EXCAVATIONS SHALL BE VERTICAL. CONTINUOUS SHORING WALLS INSTALLED PRIOR TO ANY EXCAVATION ARE PREFERRED. MAXIMUM EXCAVATION DEPTHS SHALL BE LIMITED TO FIVE (5) FEET FOR EACH STAGE OF EXCAVATION. **DESIGN OF THE SHORING SYSTEM SHALL INCLUDE LATERAL SURCHARGE DUE TO STREETCAR LIVE LOAD.**
- EXCAVATIONS BEYOND INFLUENCE LINE** - LATERAL SURCHARGE DUE TO STREETCAR LIVE LOAD NEED NOT BE CONSIDERED IN THE SHORING DESIGN. SHORED EXCAVATIONS ARE PREFERRED. SLOPED EXCAVATIONS ARE DISCOURAGED. EPSC MAY REQUIRE SLOPE STABILITY ANALYSIS FOR SLOPED EXCAVATIONS.
- ALL TRENCHES SHALL BE SHORED PER OSHA STANDARDS.
- ONLY VERTICAL EXCAVATION IS PERMITTED (NO SLOPING CUTS).
- ALL DRAWINGS AND CALCULATIONS FOR TEMPORARY SHORING SHALL BE PREPARED, SEALED, AND SIGNED BY A PROFESSIONAL ENGINEER (CIVIL OR STRUCTURAL) CURRENTLY LICENSED IN THE STATE OF TEXAS WHO HAS EXPERIENCE IN THE DESIGN OF TEMPORARY SHORING SYSTEMS OF THE TYPE BEING SUBMITTED. THE DESIGNER WILL BE RESPONSIBLE FOR THE ACCURACY OF ALL CONTROLLING DIMENSIONS AS WELL AS THE SELECTION OF SOIL DESIGN VALUES THAT ACCURATELY REFLECT THE ACTUAL FIELD CONDITIONS.

Vertical Clearances

NOTES:

- ALL CLEARANCES ARE MINIMUM.
- VERTICAL CLEARANCES APPLY UNDER ALL WEATHER CONDITIONS:
 - CONDUCTOR TEMPERATURE RANGE OF -20° TO 120° F, NO WIND, WITH FINAL UNLOADED SAG IN THE WIRE.
- FOR VOLTAGES EXCEEDING 22KV (UP TO 470KV) THE CLEARANCE SHALL BE INCREASED BY 0.4 INCHES FOR EACH 1KV, OR FRACTION THEREOF.
- VERTICAL CLEARANCES TO NON-OCS CONDUCTORS APPLY UNDER THE FOLLOWING CONDITIONS WHICHEVER PRODUCES THE LARGEST SAG IN THE CONDUCTOR:
 - CONDUCTOR SAG AT 120° F, NO WIND DISPLACEMENT, OR;
 - MAXIMUM CONDUCTOR DESIGNED OPERATING TEMPERATURE IF GREATER THAN 120° F, OR;
 - 32° F, WITH RADIAL ICE OF 0.25 INCHES.
- ALL ELECTRICAL CLEARANCES SHALL COMPLY WITH NATIONAL ELECTRICAL SAFETY CODE (NESC). AT LOCATIONS WHERE THERE ARE DISCREPANCIES BETWEEN NESC ICE THICKNESS VALUES FOR CLEARANCE AND STRUCTURAL LOADS, THE MORE CONSERVATIVE VALUE FOR THE APPLICATION SHALL BE USED.
- NON-OCS EQUIPMENT SHALL NOT BE WITHIN 10 FEET OF OCS EQUIPMENT. NO GROUNDED ITEM SHALL BE WITHIN 4 FEET OF THE OCS WITHOUT ELECTRICAL SHEETING PER SPECIFICATION.
- TRACK BED MAY BE PRESENT IN ANY LANE WITHIN THE CITY R.O.W.
- OCS POLES ARE LOCATED ON BOTH SIDES OF THE STREET.
- OCS POLES WITH CROSS SPAN CABLES ARE TYPICALLY LOCATED AT TURNS ON THE ALIGNMENT BUT MAY BE PRESENT AT OTHER LOCATIONS WHERE NECESSARY.

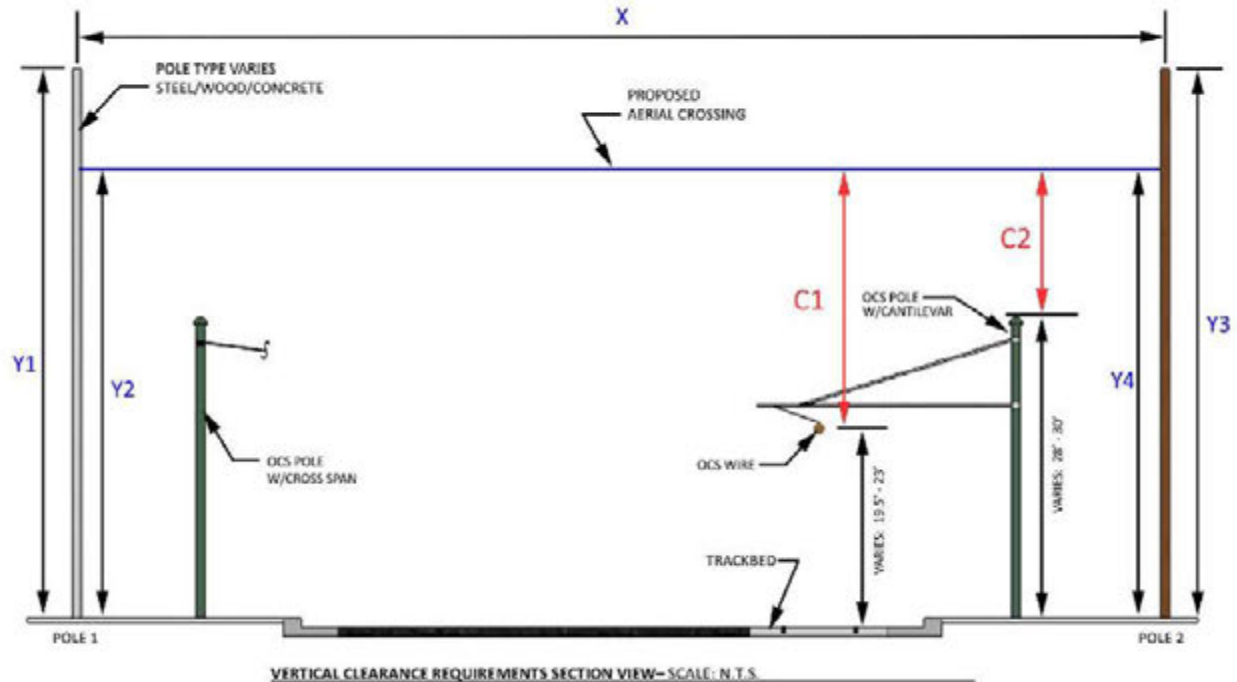

OCS WIRE AND POLE CLEARANCE REQUIREMENTS						
LEGEND	GUYS & SPAN WIRES	COMMON WIRES, CABLES & MESSANGERS	LIGHTING PROTECTION WIRES	SUPPLY LINES 0V - 750V	SUPPLY LINES 750V - 22KV	SUPPLY LINES GREATER THAN 22KV
C1 - MINIMUM CLEARANCE ABOVE OCS WIRE	4' - 0"	4' - 0"	4' - 0"	4' - 0"	6' - 0"	NOTE 3
C2 - MINIMUM CLEARANCE ABOVE OCS POLE	10' - 0"					

LEGEND

- X = LENGTH OF SPAN BETWEEN POLE 1 AND POLE 2
- Y1 = HEIGHT OF POLE 1
- Y2 = HEIGHT OF ATTACHMENT POINT ON POLE 1
- Y3 = HEIGHT OF POLE 2
- Y4 = HEIGHT OF ATTACHMENT POINT ON POLE 2

FIGURE I - 1



STREETCAR OVERHEAD CONTACT SYSTEM (OCS) WIRE/POLE VERTICAL CLEARANCES



Directional Boring

GENERAL NOTES:

1. CROSS - SECTION SHOWN IS TYPICAL OF FIELD CONDITIONS FOUND ON STREETCAR OPERATIONAL RIGHT-OF-WAY (ALIGNMENT).
2. A CONCRETE TRACK BED TYPICALLY MEASURING 8 FEET IN WIDTH AND 12 INCHES IN DEPTH (FROM FINISHED ROADWAY ELEVATION) IS FOUND THROUGHOUT THE ALIGNMENT.
3. HMAc OR CONCRETE ROADWAY PAVEMENT OR A COMBINATION OF BOTH MAY BE FOUND ON EITHER SIDE OF TRACK BED AT VARIOUS DEPTHS.
4. AN 8 INCH COMPACTED BASE IS TYPICAL UNDERNEATH THE ADJACENT HMAc OR CONCRETE PAVEMENT.
5. A 12 INCH COMPACTED BASE IS TYPICAL UNDERNEATH THE TRACK BED.
6. A 7 FEET NO BORE ZONE EXISTS FROM FINISHED TRACK/ROADWAY TO A DEPTH OF 7 FEET.
7. SUBGRADE DEPTH VARIES THROUGHOUT THE ALIGNMENT.
8. THIRD PARTY UNDERGROUND UTILITIES ARE PRESENT AT VARIOUS SIZES AND DEPTHS.
9. A 7 FEET DEPTH BORING CLEARANCE (FROM FINISHED TRACK/ROADWAY ELEVATION) IS REQUIRED FOR ALL DIRECTIONAL BORING WHILE WITHIN THE OPERATIONAL RIGHT-OF-WAY, SEE FIGURE 7.1.
10. STREETCAR TRACK ASBUILTS ARE AVAILABLE UPON REQUEST FOR SITE SPECIFIC WORK ALONG THE ALIGNMENT, COORDINATE WITH EL PASO STREETCAR.

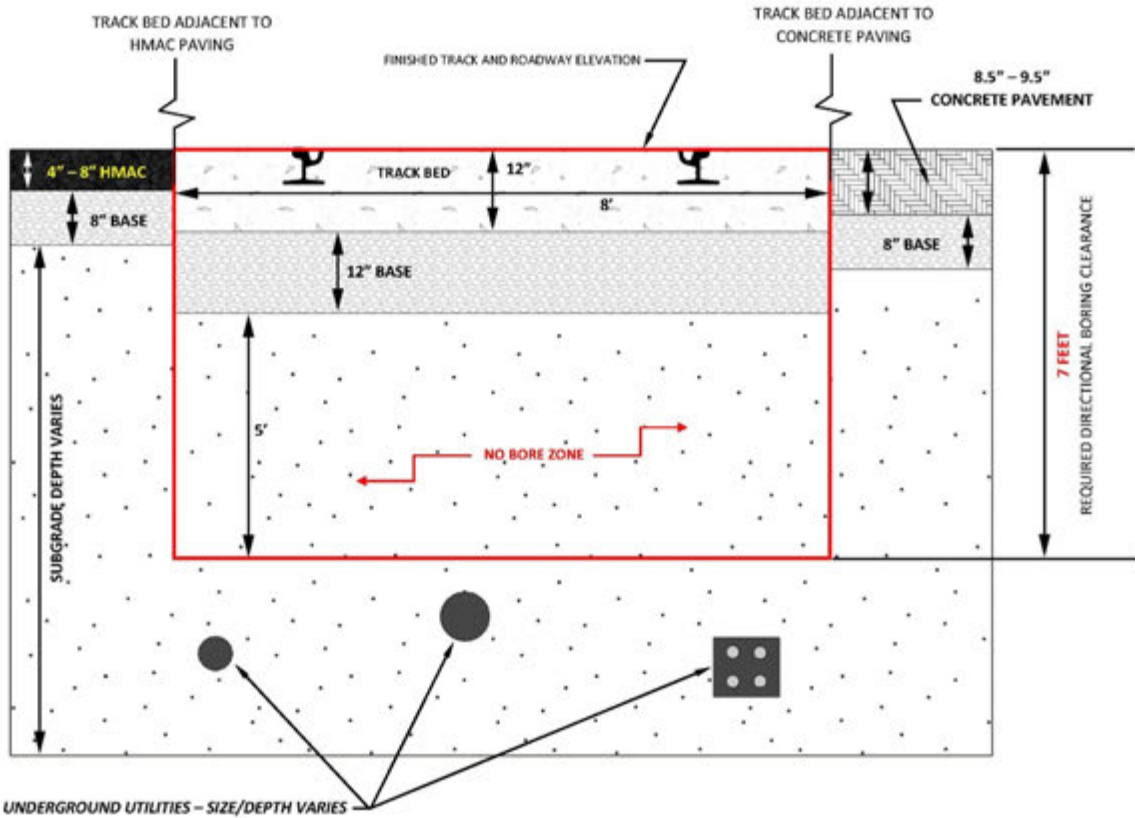

TYPICAL STREETCAR TRACK BED CROSS - SECTION - SCALE: N.T.S.

FIGURE
J - 1

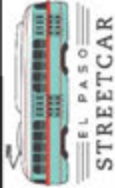

STREETCAR DIRECTIONAL BORE
CLEARANCE ZONE



Traffic Control Plans

Non-Static (Moving) Special Events within the Streetcar Operational ROW (Revenue Service Hours)

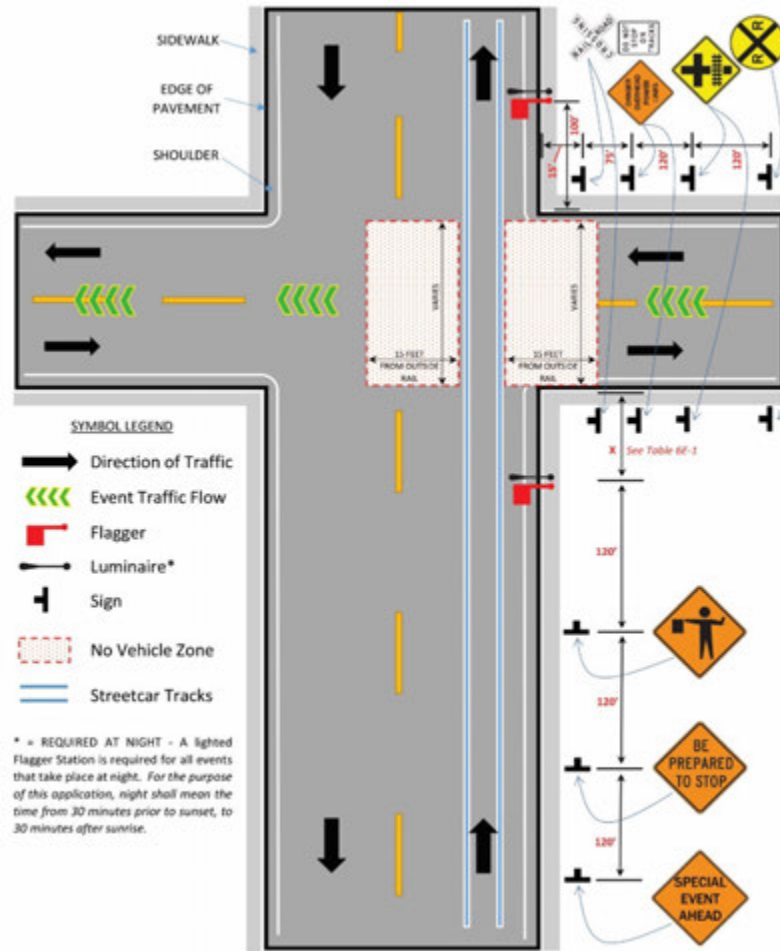

Typical Application 1 – Required Traffic Control for all Moving Special Events

SPECIAL USE ONLY in CONJUNCTION with other Typical Application(s) as Required by Permit Official- **(Revenue Service Hours)**

Traffic Control Plans

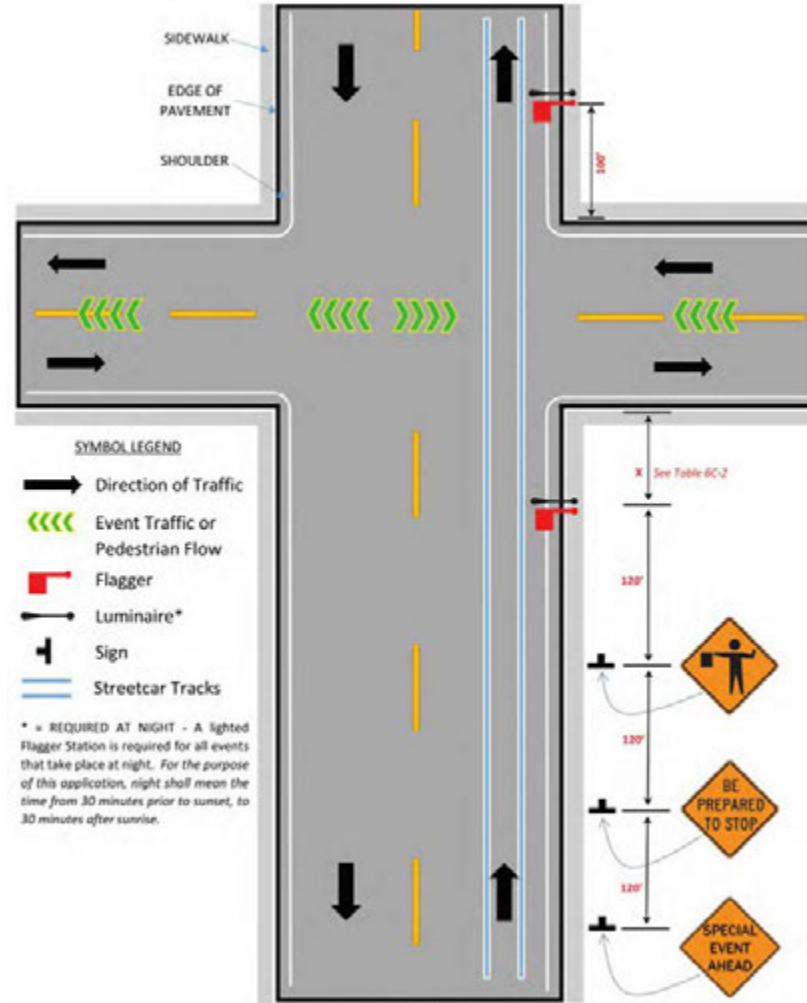

Typical Application 1-B

Traffic Control Plans

Work Zones Within the Streetcar Operational ROW (Revenue Service Hours)

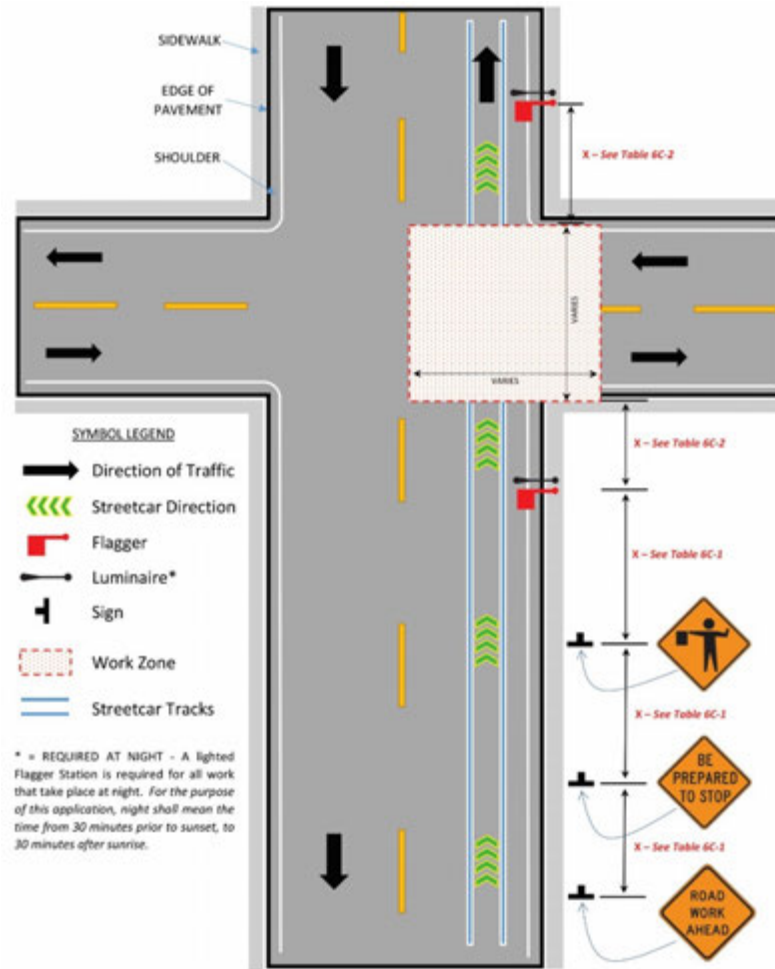

Typical Application 2 – Required Traffic Control for all Work Zones

Traffic Control Plans

Work Zones within Vicinity of Streetcar Operational ROW

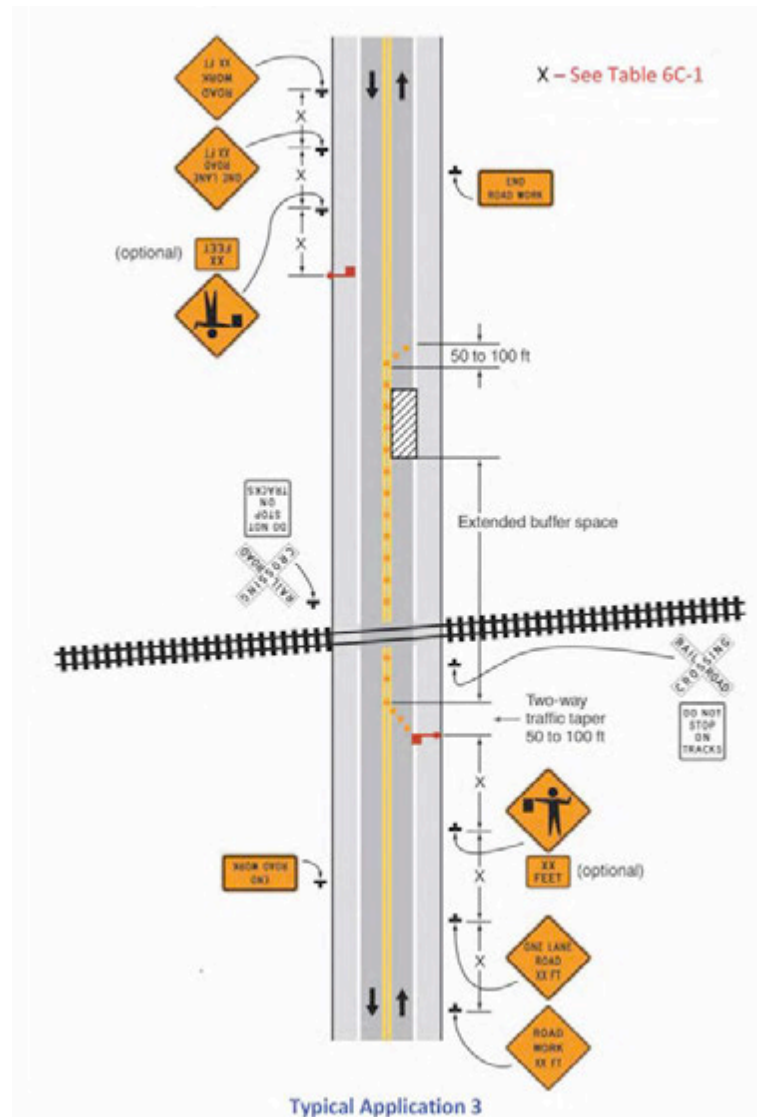

Events (Road Races or Pedestrian Traffic Control) Where Travel Path is on Same Roadway as Operational ROW

Traffic Control Plans

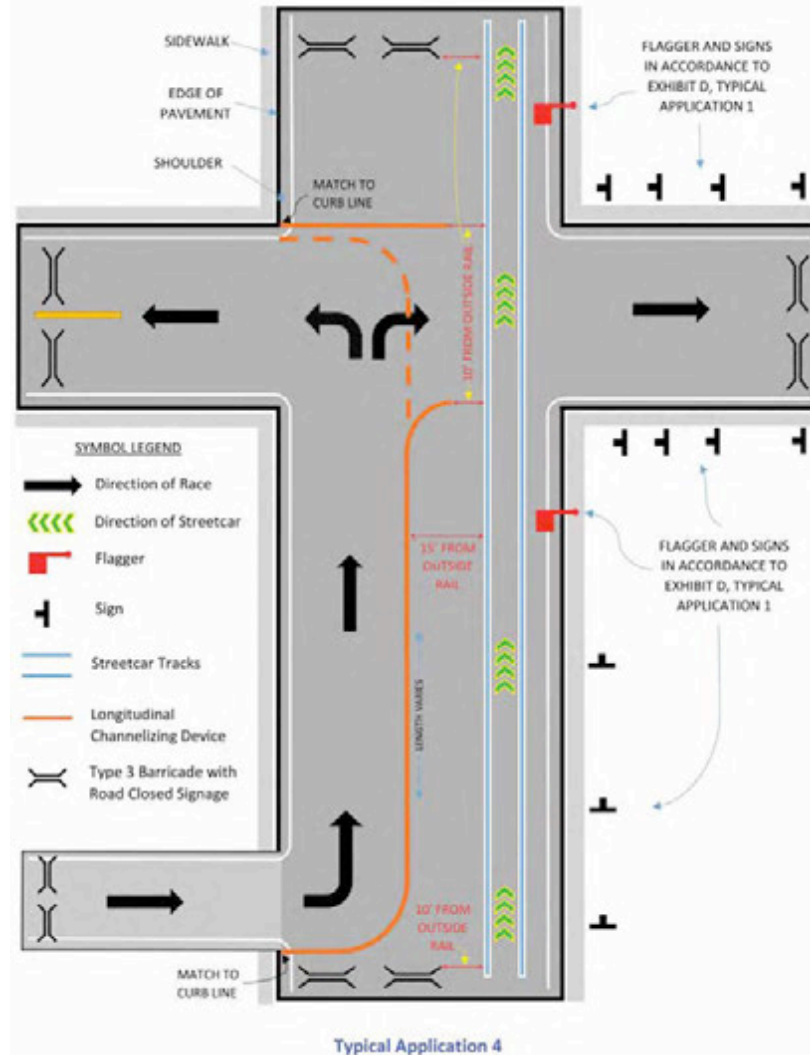

Traffic Control Plans

Events (Road Races or Pedestrian Traffic Control) Where Travel Path is on Same Roadway as Operational ROW

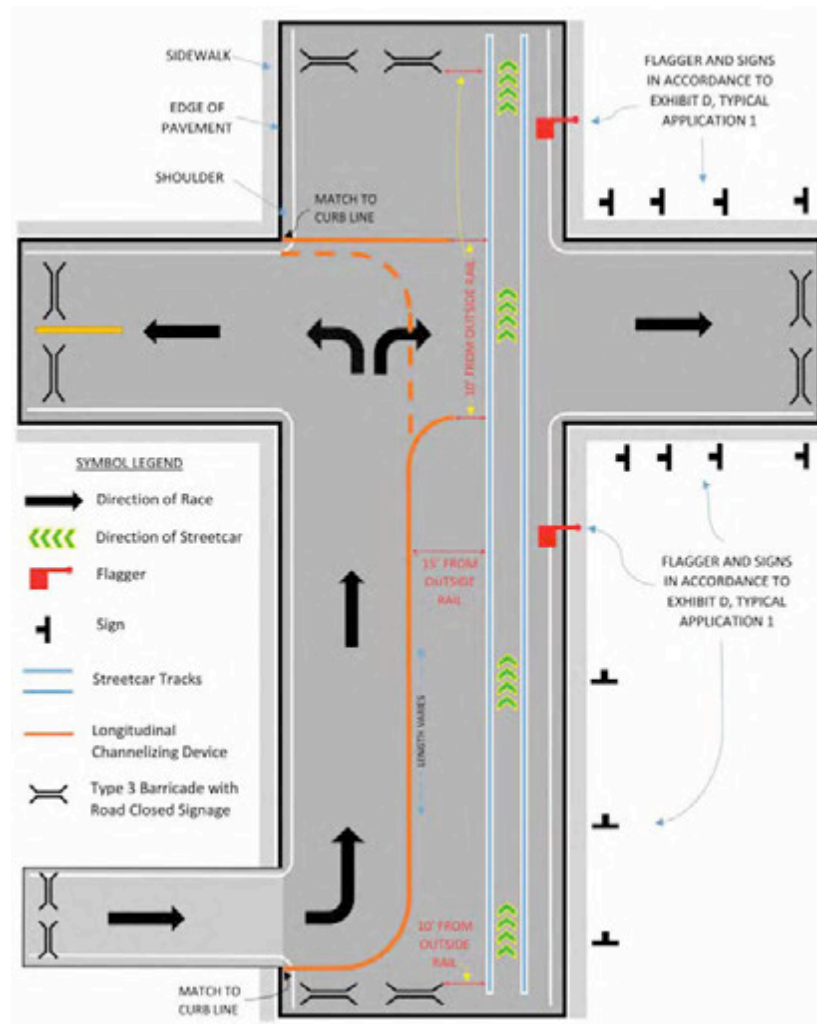

Typical Application 4

Streetcar Lane Closure on the Far Side of an Intersection (Non-Revenue Service Hours)

Traffic Control Plans

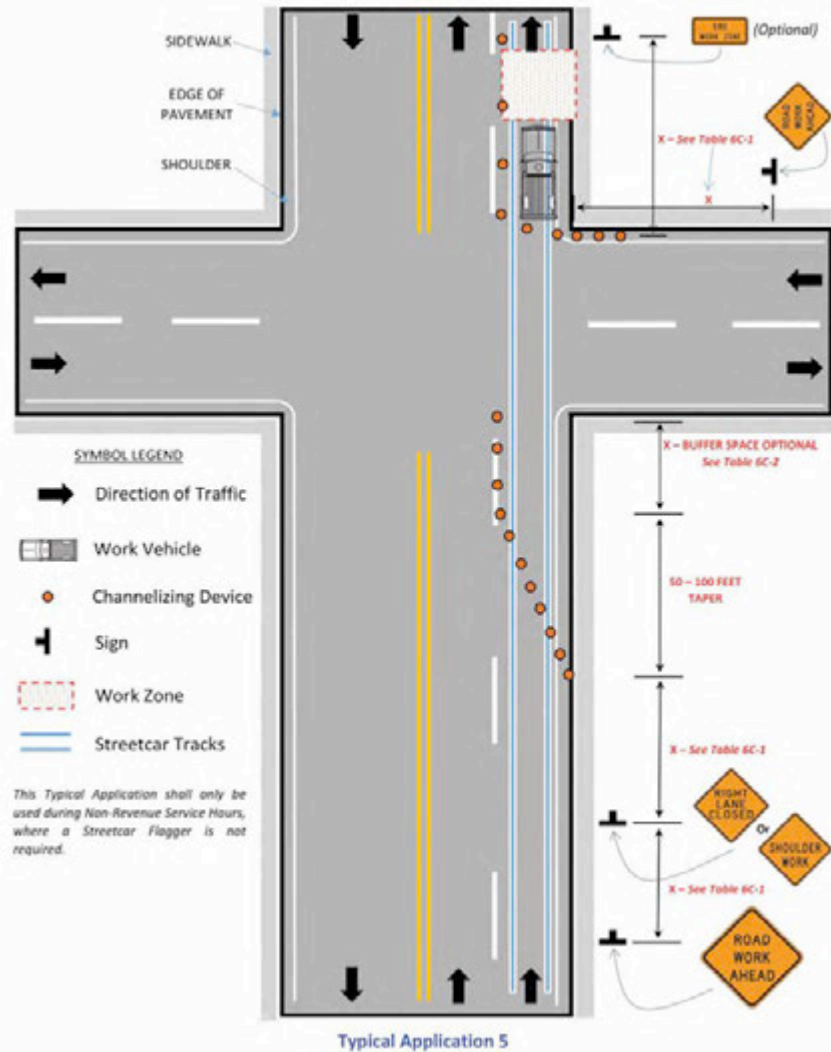

Traffic Control Plans

Shoulder Work with Minor Encroachment into Streetcar Operational ROW (Non-Revenue Service Hours)

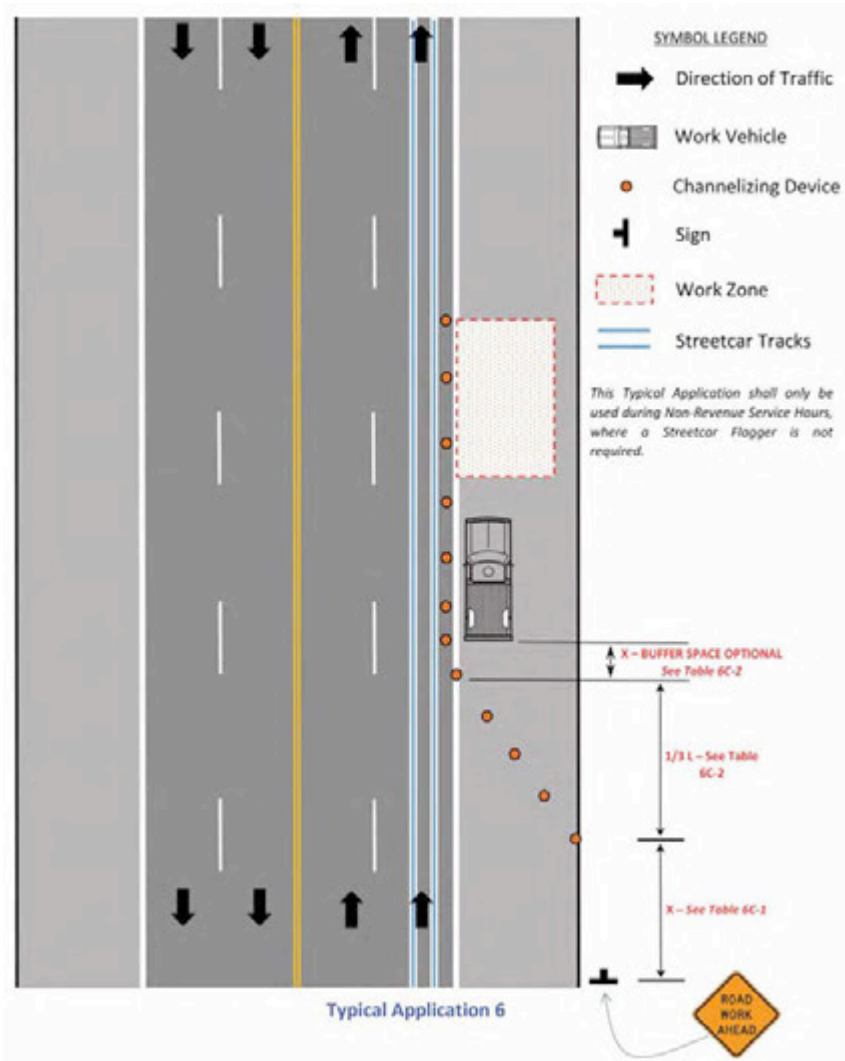

Traffic Control Plans

Short Duration or Mobile Operation on a Shoulder or Sidewalk on Streetcar Operational ROW (Non-Revenue Service Hours)

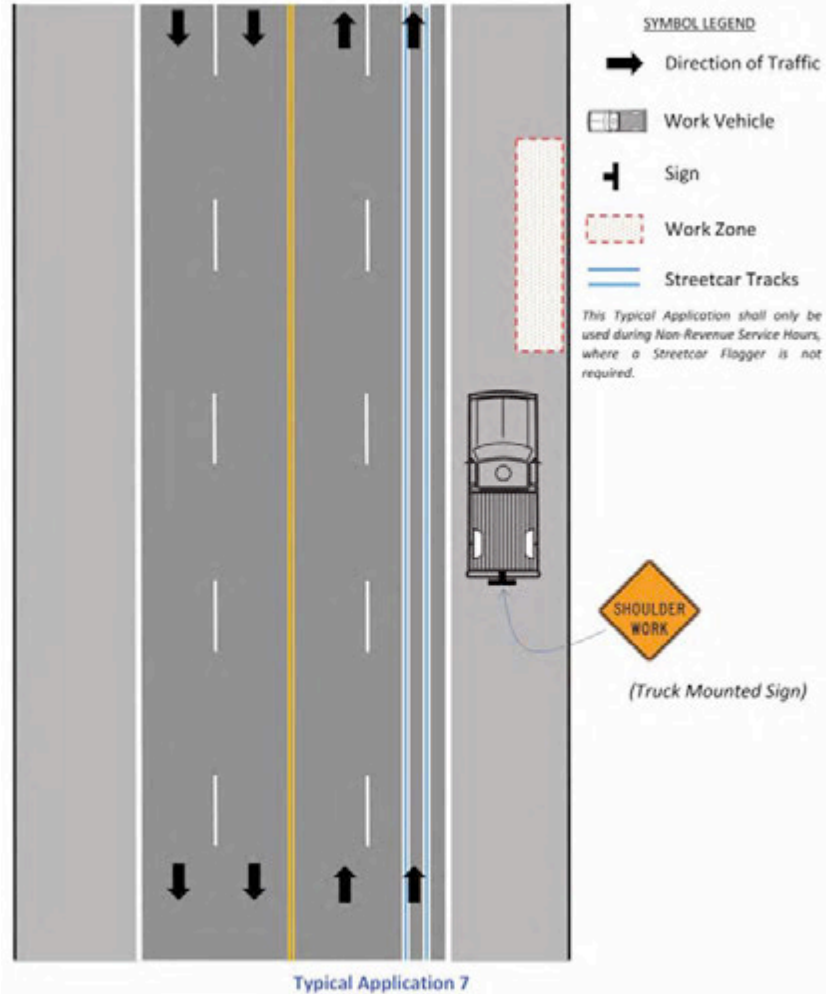

Special Pedestrian Traffic Control for Activities within the Vicinity of El Paso Streetcar Operational ROW (Revenue Service Hours)

Traffic Control Plans

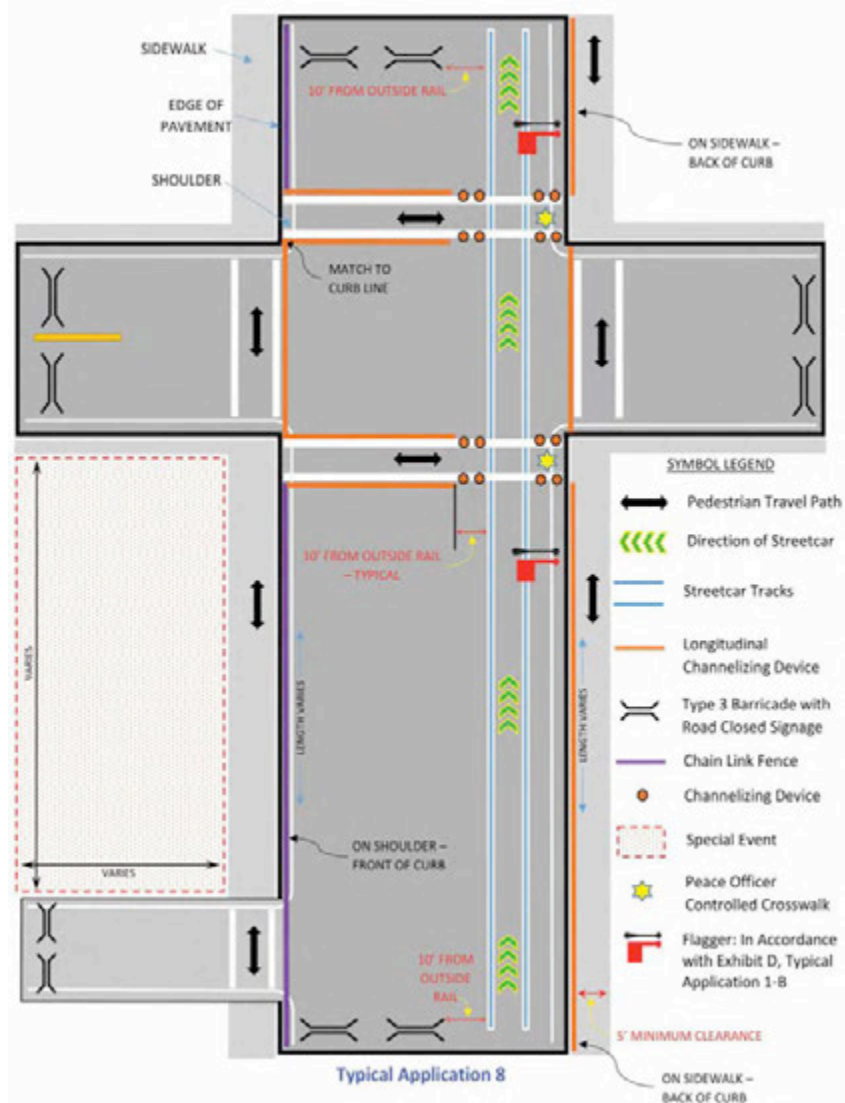

Flagger Stations

Table 6E-1. Stopping Sight Distance as a Function of Speed

Speed*	Distance
20 mph	115 feet
25 mph	155 feet
30 mph	200 feet
35 mph	250 feet
40 mph	305 feet
45 mph	360 feet
50 mph	425 feet
55 mph	495 feet
60 mph	570 feet
65 mph	645 feet
70 mph	730 feet
75 mph	820 feet
80 mph	910 feet

* Posted speed, off-peak 85th-percentile speed prior to work starting, or the anticipated operating speed

Table 6C-1. Suggested Advance Warning Sign Spacing

Road Classification	Posted Speed (MPH)	Sign Spacing "X" (Feet)
Conventional Highway	25	100
	30	120
	35	160
	40	240
	45	320
	50	400
	55*	500
	60*	600
	65*	700
	70*	800
	75*	900
80*	1000	
Expressway or Freeway	All Speeds	See Typical Applications (Chapter 6H) **

* Distance between signs should be increased to have 1500 feet advance warning (See Section 6C.04.07)

** Distance between signs should be increased to have 1/2 mile or more advance warning. (See Section 6C.04.05)

Table 6C-2. Longitudinal Buffer Space

Speed* (mph)	Length (Feet)
20	40
25	60
30	90
35	120
40	155
45	195
50	240
55	295
60	350
65	410
70	475
75	540
80	615

* Posted speed Based upon American Association of State Highway and Transportation Officials (AASHTO) braking distance portion of stopping sight distance for wet and level pavements (A Policy on Geometric Design of Highways and Streets, AASHTO, 2004, P. 112). This AASHTO document also recommends adjustments for the effect of grade on stopping and variation for trucks.



Traffic Control Plans

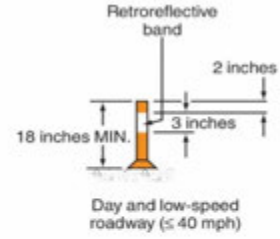
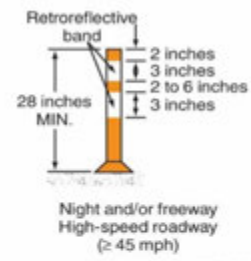

TUBULAR MARKERS

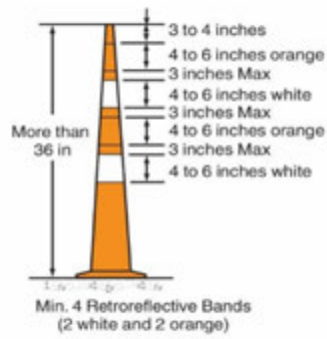

CONES

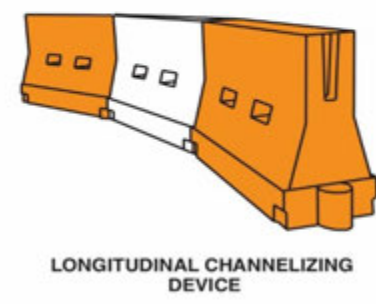
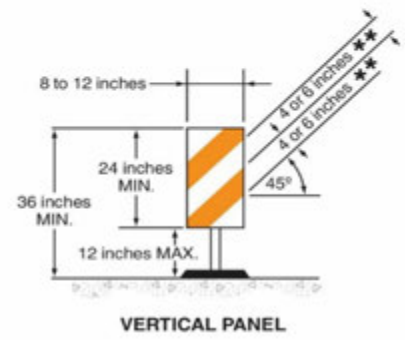

Channelizing Devices

Traffic Control Plans

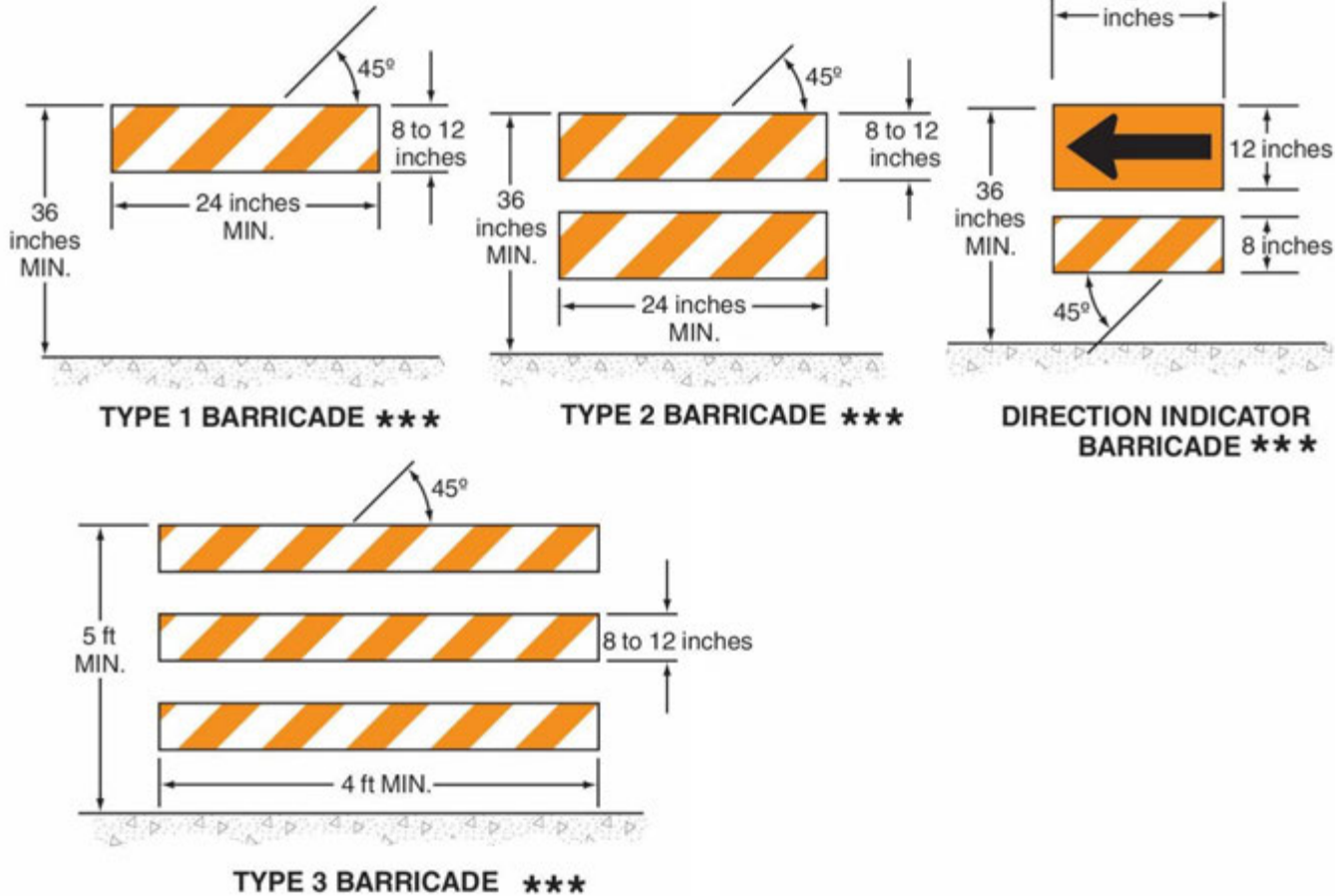

*** Rail stripe widths shall be 6 inches, except that 4-inch wide stripes may be used if rail lengths are less than 36 inches. The sides of barricades facing traffic shall have retroreflective rail faces.

Work Zone

- Area between two flaggers.
(yellow and green flags)
- Reduce speed (5 mph)

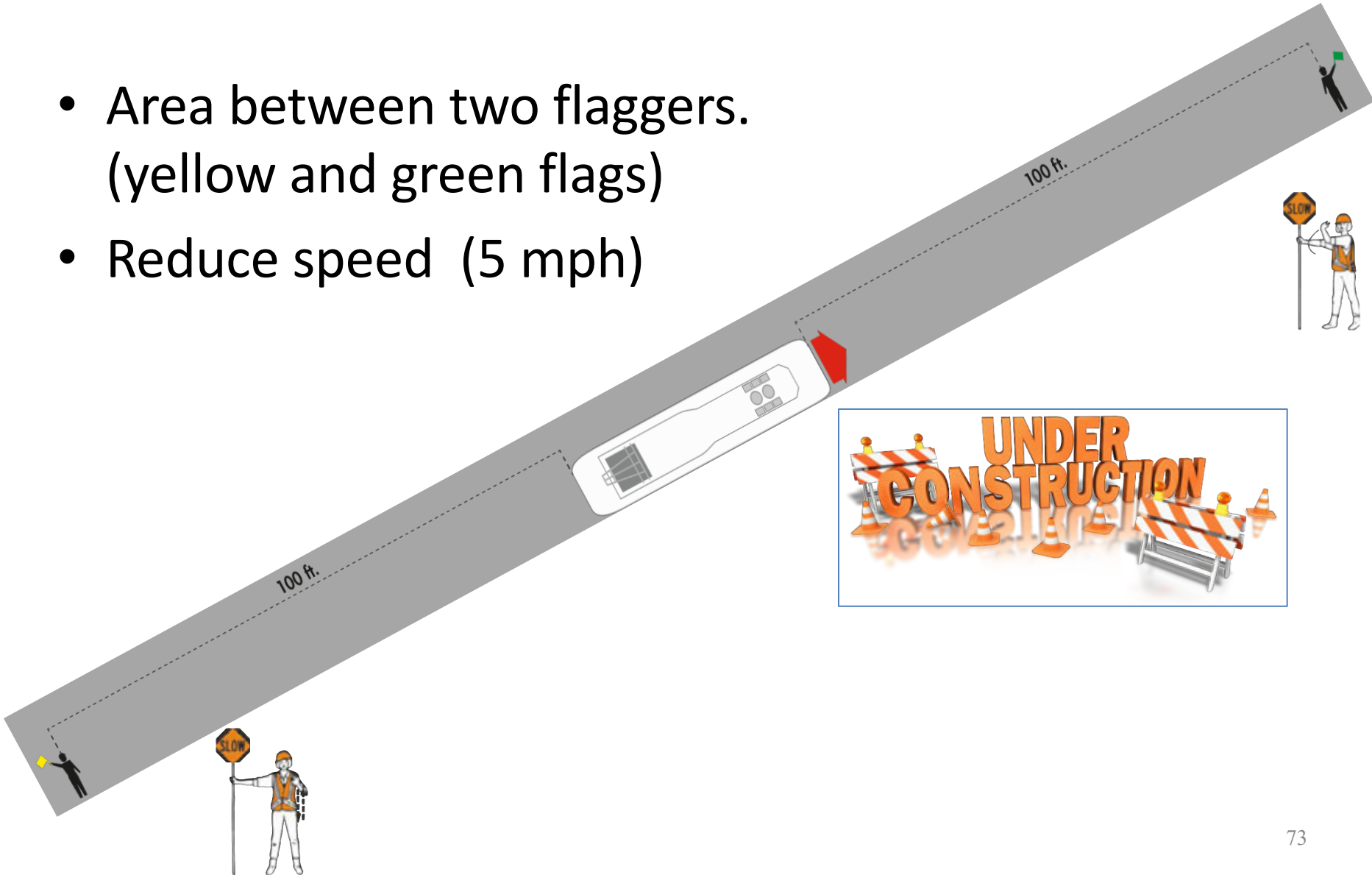

Reduce speed area

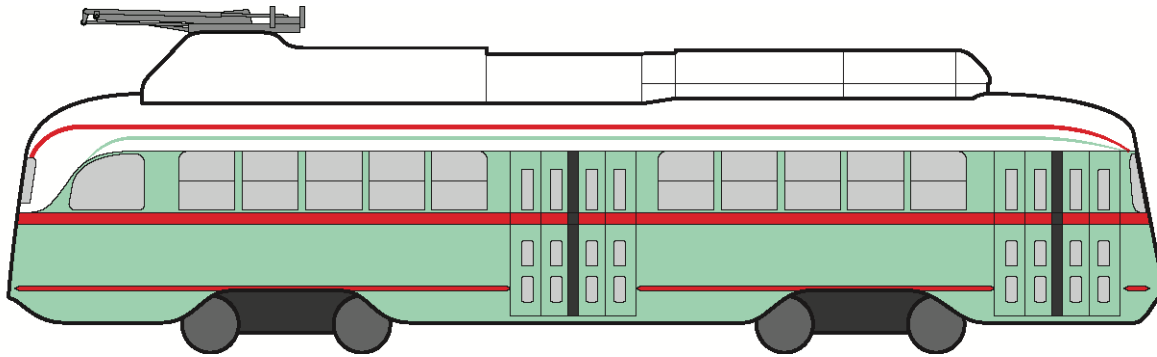

Stop

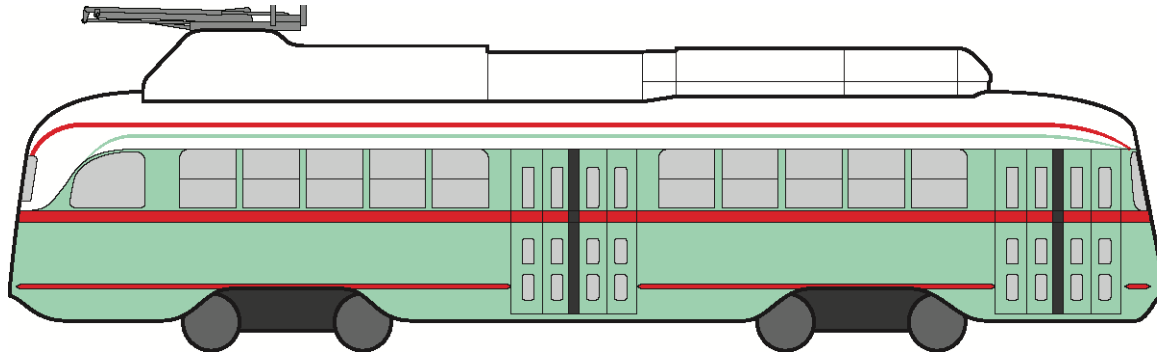

Proceed

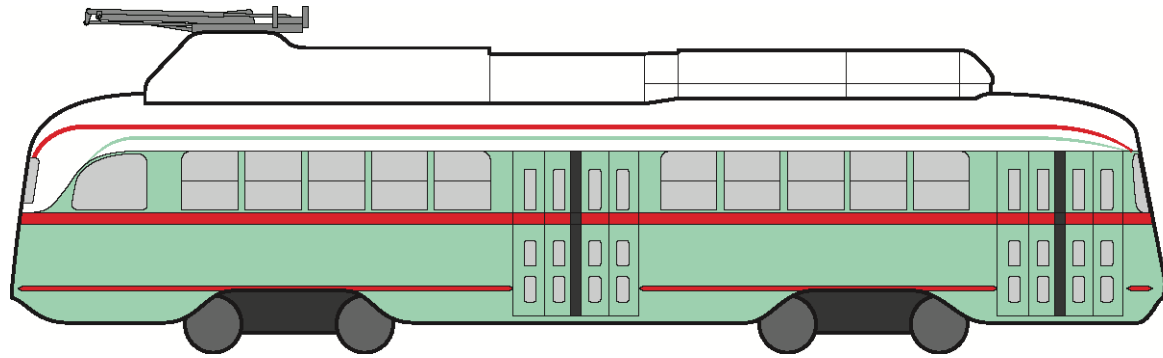

Be Streetcar Safe!

Lynette Perea
Streetcar Safety Officer
Tel. (915) 212-3466
Mobile: (915) 255-6085
BalcazarJM@elpasotexas.gov

Johnny Balcazar
Streetcar Safety Manager
Tel. (915) 212-3466
Mobile: (915) 255-6085
BalcazarJM@elpasotexas.gov



Terri Davila
Planning Specialist
Tel. (915) 212-3451
Mobile: (915) 271-5150
teresa.davila@elpasotexas.gov

Everett Esparza
Chief Streetcar Officer
Tel. (915) 212-3464
Mobile: (915) 503-6650
EsparzaEX@elpasotexas.gov

Felix Minjarez
Streetcar Operations Superintendent
Tel. (915) 212-3455
Mobile: (915) 873-7605
MinjarezFH@elpasotexas.gov

<http://www.sunmetro.net/streetcar>
<https://aca-prod.accela.com/ELPASO/Default.aspx>

(Citizen Access)